

Brande!

Quality by design

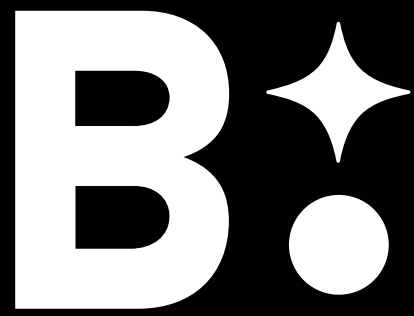

Katalog produktów
2023



Quality by design

✦ Quality

Kuchnia to inwestycja na lata, dlatego najwyższa jakość to nasz priorytet.



BrandeTec+

Zlewozmywaki Brande produkujemy z wykorzystaniem zaawansowanych rozwiązań technicznych na bazie najwyższej jakości certyfikowanych europejskich surowców o podwyższonych właściwościach mechanicznych. Rygorystyczna, wieloetapowa kontrola surowców gwarantuje wysoką jakość i powtarzalność naszych produktów. Prowadzimy ścisły nadzór nad przebiegiem produkcji, dzięki czemu zawsze przebiega on w optymalnych warunkach. Ponadto aktywnie współpracujemy z naukowcami z wiodących ośrodków badawczych, aby nieustannie rozwijać i udoskonalać naszą ofertę. Dysponujemy szeregiem autorskich rozwiązań, które są unikalne nie tylko w skali krajowej ale także światowej.

Technologia BrandeTec+ bazuje na aktywnych jonach srebra, zapewnia najwyższy poziom higieny ograniczając rozwój bakterii i drobnoustrojów aż o 99%.



Gwarancja 40 lat

Opracowana w ramach działalności badawczo - rozwojowej autorska technologia charakteryzuje się optymalnym składem, co przekłada się na ponadprzeciętną wytrzymałość i trwałość zlewozmywaków Brande.



Wyprodukowane w PL

Dzięki produkcji we własnej fabryce kontrolujemy wszystkie procesy wpływające na jakość finalnego produktu a nasze zlewozmywaki przechodzą proces rygorystycznej kontroli jakości.

● Design

Zaprojektowane by rozwiązywać codzienne zadania w piękny sposób.

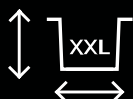

Największe komory XXL

Projektując zlewozmywaki Brande stawiamy na Twoją codzienną wygodę proponując największe komory mieszczące duże naczynia a nawet blachy do pieczenia. Komora XXL to maksymalna wielkość komory do danej szafki. Modele z komorą MAX poszerzamy (rozmiar góra-dół) o kolejne 30 mm do aż 530 mm wykorzystując zalety blatów szerszych niż 600mm lub wysp kuchennych dając Tobie jeszcze większą wygodę użytkowania.



Concept Line & Concept R

Ponadprzeciętne wzornictwo dzięki stalowej maskownicy odpływu, która nadaje wyjątkowo nowoczesny design - prostokątna w konceptach "R" oraz w formie eleganckiego odpływu liniowego w konceptach "Line".



Pocket

Zrozumienie potrzeb Konsumenta to podstawa, dlatego wsłuchujemy się w Twoje potrzeby i tworzymy produkty ułatwiające codzienną pracę w kuchni.

Linia produktów POCKET do nowoczesnych małych i średnich kuchni z wygodnym organizerem na deskę, myjkę oraz płyn do mycia naczyń.



Level

Efektywna na prace na wielu poziomach - zamiast zlewozmywak w wielofunkcyjną stację roboczą, dzięki akcesoriom instalowanym na górze zlewozmywaka (deski) oraz na poziomie Level (wkładki ociekowe czy zwijane ociekacze).

✦● Zlewozmywaki nablátowe

od 30 cm



Solar Slim 260-30
str. 45

od 40 cm



Zone Pocket 380-40
str. 20



Swift Slim 360-40
str. 32



Joy 400-40
str. 48



Solar Slim 360-40
str. 44



Point 620-40
str. 73



Mach 620-40
str. 87

od 45 cm



Zone Pocket 430-45
str. 20



Swift Slim 410-45
str. 37



Solar Slim 410-45
str. 43



Lotus Max 440-45
str. 63



Joy Max 440-45
str. 47



Joy Rond 500-45
str. 89



Shape 780-45
str. 55



Shape 620-45
str. 57



Link 780-45
str. 81



Link 620-45
str. 83



Mach 780-45
str. 85

od 50 cm



Zone Pocket 480-50
str. 20



Swift Slim 460-50
str. 32



Zone 490-50
str. 29



Solar Slim 460-50
str. 42

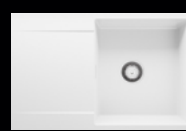

Spire 780-50
str. 66



Spire 620-50
str. 69



Link 780-50
str. 80



Link 620-50
str. 82

od 60 cm



Look Max 580-60
str. 13



High Slim 560-60
str. 15



Peak Max 580-60
str. 17



Hype Slim 560-60
str. 19



Zone Pocket 580-60
str. 25



Zone Max 580-60
str. 26



Zone 590-60
str. 27



Whip Max 580-60
str. 31



Swift Slim Grande 560-60
str. 32



Swift Slim 560-60
str. 35



Solar Slim 560-60
str. 41

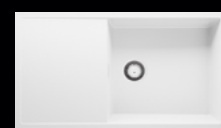

Shape 900-60
str. 51

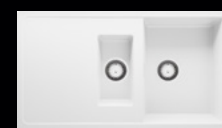

Shape Dual 900-60
str. 52

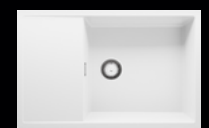

Shape 780-60
str. 53

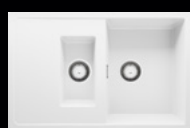

Shape Dual 780-60
str. 54



Lotus 900-60
str. 59



Lotus 780-60
str. 61



Lotus 590-60
str. 62

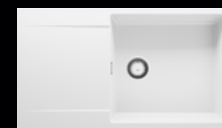

Spire 900-60
str. 65



Spire 700-60
str. 67

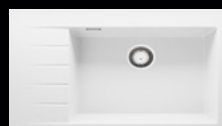

Point 900-60
str. 91

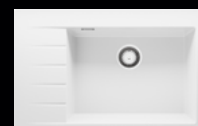

Point 780-60
str. 71



Link 900-60
str. 75



Link Dual 900-60
str. 76

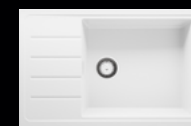

Link 780-60
str. 78



Link Dual 780-60
str. 79

od 70 cm



Solar Slim 660-70
str. 40

od 80 cm



Swift Dual Slim 760-80
str. 32



Zone 780-80
str. 23



Swift Slim 760-80
str. 34



Swift Slim Low Cut 760-80
str. 32



Zone Dual 780-80
str. 22



Solar Slim 760-80
str. 39



Lotus Dual 780-80
str. 60



Link Dual 900-80
str. 77

od 90 cm



Zone 900-90
str. 21

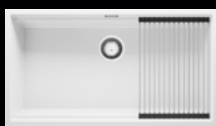

Swift Slim 860-90
str. 33

✦● Zlewozmywaki podblatowe

od 30 cm



Solar 260-30
str. 107

od 40 cm



Swift 360-40
str. 94



Solar 360-40
str. 106

od 45 cm



Swift 410-45
str. 99



Solar 410-45
str. 105

od 50 cm



Swift Slim 460-50
str. 94



Solar 460-50
str. 104

od 60 cm



High 560-60
str. 91



Hype 560-60
str. 93



Swift Grande 560-60
str. 94



Swift 560-60
str. 97



Solar 560-60
str. 103

od 70 cm

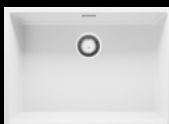

Solar 660-70
str. 102



Swift Dual 760-80
str. 94



Swift 760-80
str. 96



Swift Low Cut 760-80
str. 94

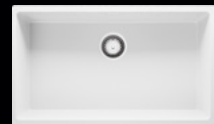

Solar 760-80
str. 101

od 90 cm



Swift 860-90
str. 95

Spersonalizuj swój zlewozmywak



Osprzęt automatyczny

Steruj zamknięciem odpływu za pomocą wygodnego przycisku premium.

od 49,99 PLN - dopłata do ceny podstawowej modelu



Osprzęt z magnetyczną maskownicą odpływu

Nowoczesne wzornictwo dzięki magnetycznej maskownicy odpływu dla osprzętu manualnego.

od 49,99 PLN - dopłata do ceny podstawowej modelu 1 komorowego
od 99,99 PLN - dopłata do ceny podstawowej modelu 1,5 i 2 komorowego



Osprzęt All Black

Nadaj swojemu zlewozmywakowi modny design, dzięki osprzętowi w kolorze czarnego matu.

od 49,99 PLN - dopłata do ceny podstawowej modelu 1 komorowego - manualny
od 99,99 PLN - dopłata do ceny podstawowej modelu 1,5 i 2 komorowego - manualny
od 99,99 PLN - dopłata do ceny podstawowej modelu 1 komorowego - automatyczny
od 149,99 PLN - dopłata do ceny podstawowej modelu 1,5 i 2 komorowego - automatyczny

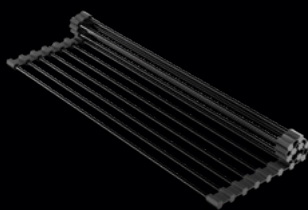

Czarny zwijany ociekacz

Zwijany ociekacz w kolorze czarnego matu idealnie uzupełni czarną komorę zlewozmywaka i osprzętu All Black.

od 99,99 PLN - dopłata do ceny podstawowej modeli Level



Line i Concept R czarny mat

Stalowe maskownice odpływu

od 49,99 PLN - dopłata do ceny podstawowej modeli R
od 99,99 PLN - dopłata do ceny podstawowej modeli Line

Wielofunkcyjna stacja robocza

Stwórz wielofunkcyjną stację roboczą dzięki praktycznej wkładce ociekowej montowanej w systemie Level oraz desce kuchennej w wykończeniu klasycznego drewna bukowego lub dębowego oraz odpornego nowoczesnego tworzywa HPL.



Wkładka ociekowa
od 199,99 PLN



Deska kuchenna bukowa
od 199,99 PLN



Deska kuchenna dębowa
od 249,99 PLN

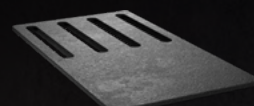

Deska kuchenna HPL
od 249,99 PLN





Na wizualizacji model Zone Pocket 580-60

Zlewozmywaki z serii Zone Pocket



Zone Pocket
580-60

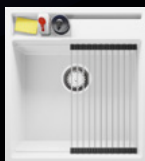

Zone Pocket
480-50

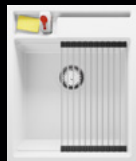

Zone Pocket
430-45



Zone Pocket
380-40

Zrozumienie Twoich potrzeb to dla nas priorytet, dlatego uważnie się w nie wsłuchujemy i tworzymy produkty ułatwiające codzienne, kuchenne przygody.

✦● Innowacyjny model Pocket

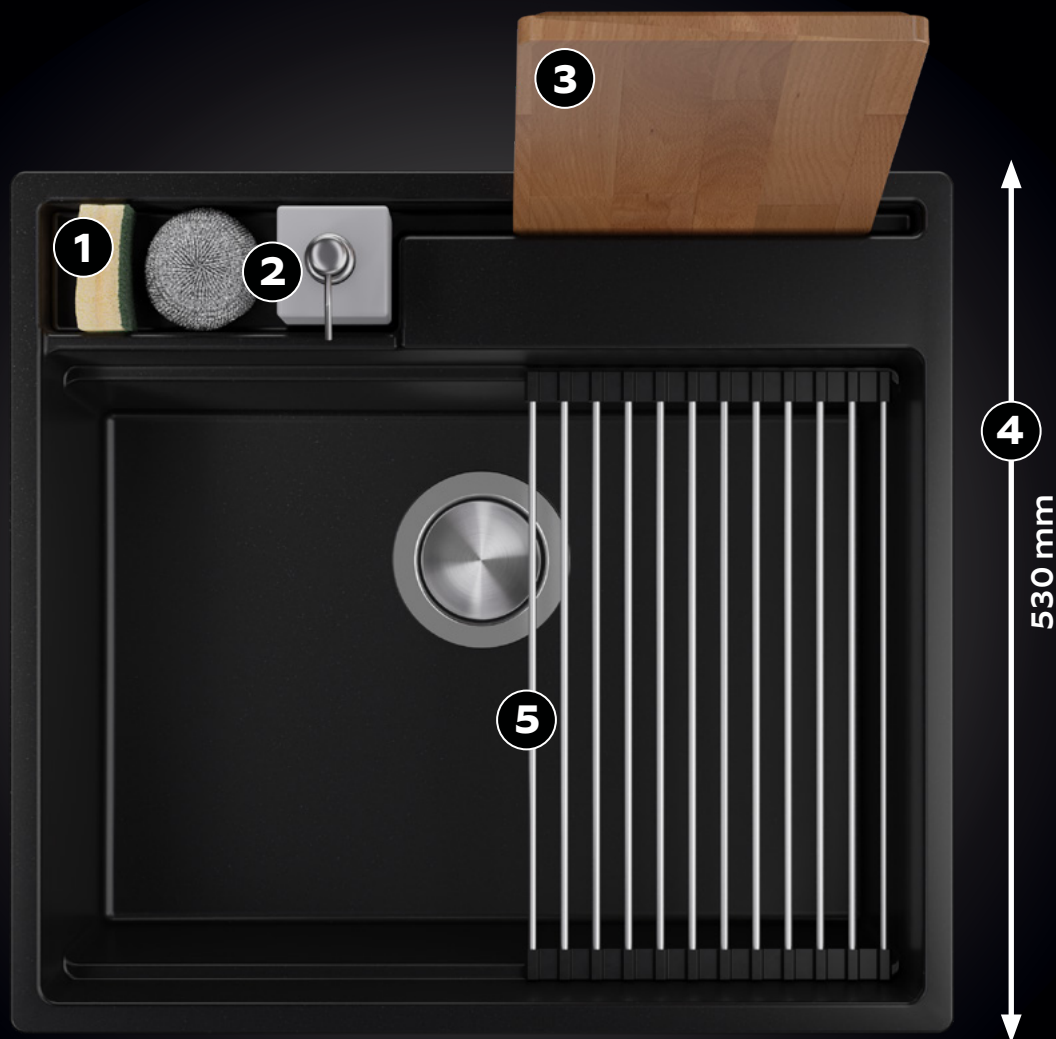

Funkcjonalna stacja robocza dla małych i średnich kuchni zamknięta w prostej i minimalistycznej formie.

- 1** Innowacyjny organizator na myjkę z odpływem dla higienicznego i bezpiecznego użytkowania
- 2** Przestrzeń na 2 butelki - np. płynu do mycia naczyń mydła/balsamu do rąk
- 3** Kieszon do przechowywania deski kuchennej - wraz z odpływem wody do przelewu
- 4** Komora XXL, dzięki wydłużeniu zlewozmywaka do 530 mm oraz projektowi maksymalizujące dopasowanie do szafki 60 cm
- 5** Stacja robocza pozwalająca na efektywną pracę z wykorzystaniem akcesoriów takich jak zwijany ociekacz, wkładka ociekowa lub deska kuchenna



komora XXL



komora MAX



system Level





◆ ● Zlewozmywaki nablátowe



Look

◆● Look Max 560-60

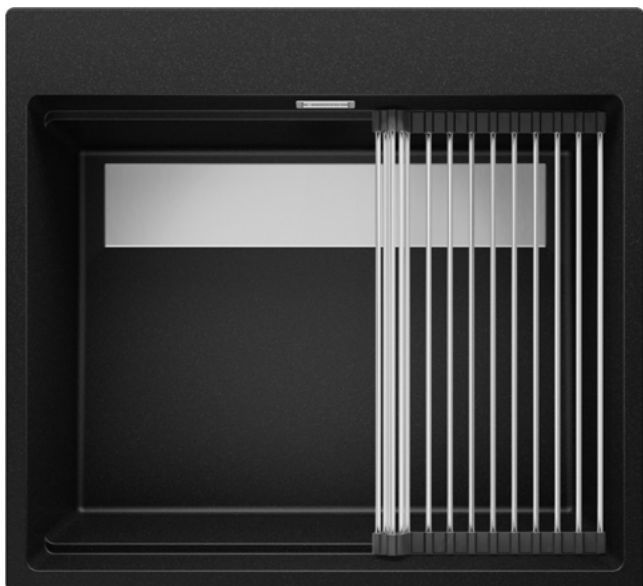

	Black	B#MS6.KC.SM.001
	Black Metallic	B#MS6.KM.SM.001
	Graphite	B#MS6.KG.SM.001
	Grey	B#MS6.KS.SM.001
	Beige	B#MS6.KB.SM.001
	White	B#MS6.KW.SM.001

Cena katalogowa od:
2 649,99 PLN

W zestawie:



Osprzęt manualny



Zwijany ociekacz chrom



Maskownica "Line"

Dane techniczne

Rodzaj:	zlewozmywak nablatowy
Rozmiar szafki:	od 60 cm
Wymiary zewnętrzne:	580 x 530 mm
Wymiary komory:	540 x 430 x 200 mm
Odwracalny:	Nie
Liczba otworów:	5 podfrezowanych otworów

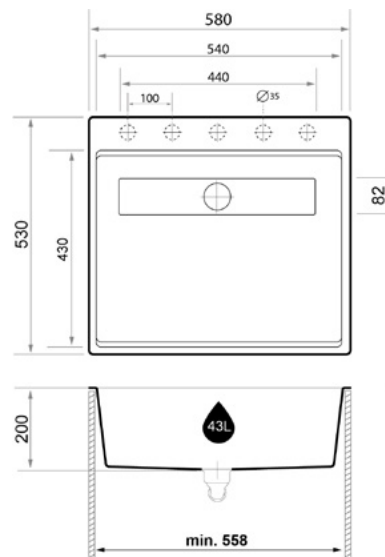

Dostępne akcesoria dodatkowe:



Osprzęt automatyczny



Czarna maskownica "Line"



Zwijany ociekacz czarny mat



Wkładka ociekowa



Deska kuchenna bukowa lub dębowa



Deska kuchenna HPL



do szafki od 60cm



40 lat gwarancji



BrandeTec+



odporność na zarysowania



odporność na przebarwienia



odporność na wysoką temperaturę



odporność na zabrudzenia



odporność na uderzenia



odporność na szok termiczny



łatwe w czyszczeniu



nie traci koloru



elastyczność projektowania



komora XXL



komora MAX



system Level



High Slim

◆● High Slim 560-60

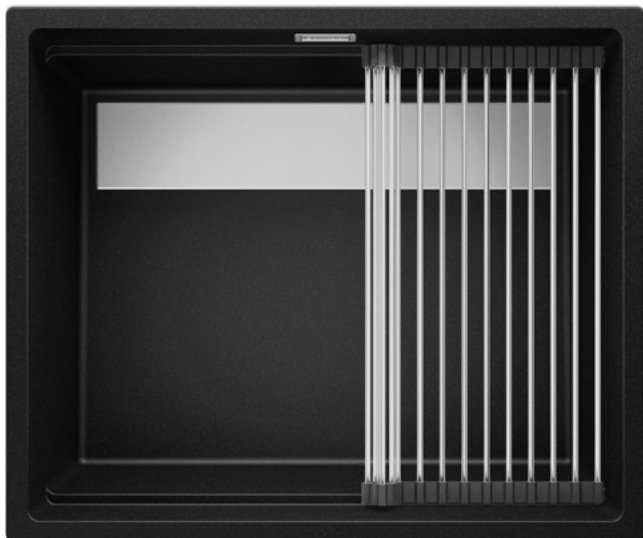

	Black	B#MZ6.KC.SM.001
	Black Metallic	B#MZ6.KM.SM.001
	Graphite	B#MZ6.KG.SM.001
	Grey	B#MZ6.KS.SM.001
	Beige	B#MZ6.KB.SM.001
	White	B#MS6.KW.SM.001

Cena katalogowa od:
2 649,99 PLN

W zestawie:



Osprzęt manualny



Zwijany ociekacz chrom



Maskownica "Line"

Dane techniczne

Rodzaj:	zlewozmywak nablatowy
Rozmiar szafki:	od 60 cm
Wymiary zewnętrzne:	560 x 470 mm
Wymiary komory:	520 x 430 x 200 mm
Odwracalny:	Nie

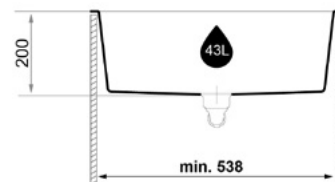
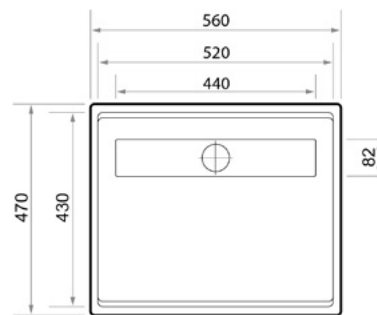

Dostępne akcesoria dodatkowe:



Osprzęt automatyczny



Czarna maskownica "Line"



Zwijany ociekacz czarny mat



Wkładka ociekowa



Deska kuchenna bukowa lub dębowa



Deska kuchenna HPL



do szafki od 60cm



40 lat gwarancji



BrandeTec+



odporność na zarysowania



odporność na przebarwienia



odporność na wysoką temperaturę



odporność na zabrudzenia



odporność na uderzenia



odporność na szok termiczny



łatwe w czyszczeniu



nie traci koloru



komora XXL



system Level



✦ Peak

◆● Peak Max 580-60

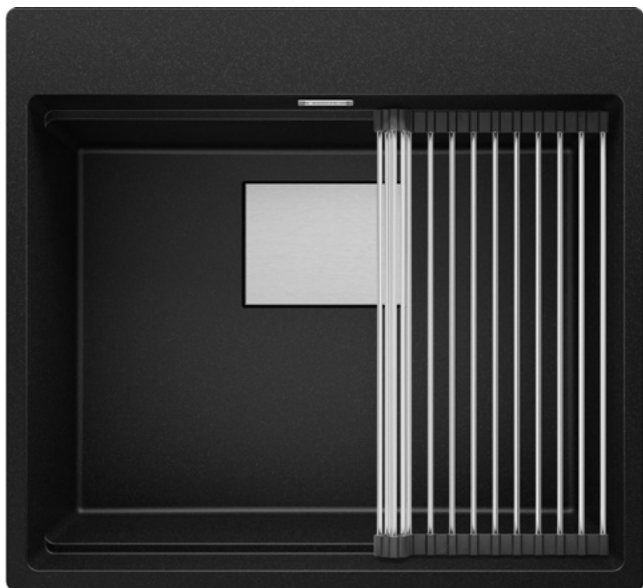

	Black	B#MM6.KC.SM.001
	Black Metallic	B#MM6.KM.SM.001
	Graphite	B#MM6.KG.SM.001
	Grey	B#MM6.KS.SM.001
	Beige	B#MM6.KB.SM.001
	White	B#MM6.KW.SM.001

Cena katalogowa od:
2 149,99 PLN

W zestawie:



Osprzęt manualny



Zwijany ociekacz chrom

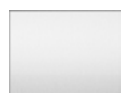

Maskownica "R"

Dane techniczne

Rodzaj:	zlewozmywak nablatowy
Rozmiar szafki:	od 60 cm
Wymiary zewnętrzne:	580 x 530 mm
Wymiary komory:	540 x 430 x 200 mm
Odwracalny:	Nie
Liczba otworów:	5 podfrezowanych otworów

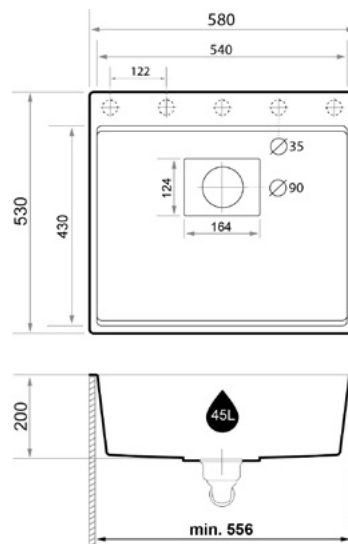

Dostępne akcesoria dodatkowe:



Osprzęt automatyczny



Czarna maskownica "R"



Zwijany ociekacz czarny mat



Wkładka ociekowa



Deska kuchenna bukowa lub dębowa



Deska kuchenna HPL



do szafki od 60cm



40 lat gwarancji



BrandeTec+



odporność na zarysowania



odporność na przebarwienia



odporność na wysoką temperaturę



odporność na zabrudzenia



odporność na uderzenia



odporność na szok termiczny



łatwe w czyszczeniu



nie traci koloru



elastyczność projektowania



komora XXL



komora MAX



system Level



✦ Hype Slim

◆● Hype Slim 560-60

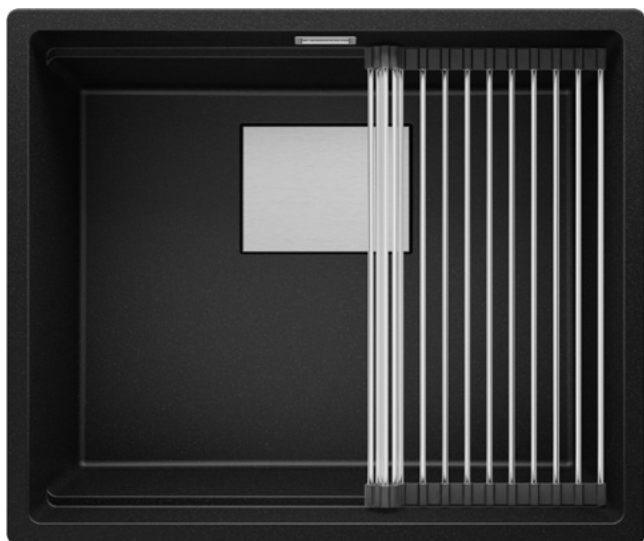

	Black	B#MG6.KC.SM.001
	Black Metallic	B#MG6.KM.SM.001
	Graphite	B#MG6.KG.SM.001
	Grey	B#MG6.KS.SM.001
	Beige	B#MG6.KB.SM.001
	White	B#MG6.KW.SM.001

Cena katalogowa od:
2 149,99 PLN

W zestawie:



Osprzęt manualny



Zwijany ociekacz chrom



Maskownica "R"

Dane techniczne

Rodzaj:	zlewozmywak nablatory
Rozmiar szafki:	od 60 cm
Wymiary zewnętrzne:	560 x 470 mm
Wymiary komory:	520 x 430 x 200 mm
Odwracalny:	Nie

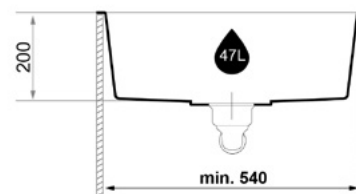
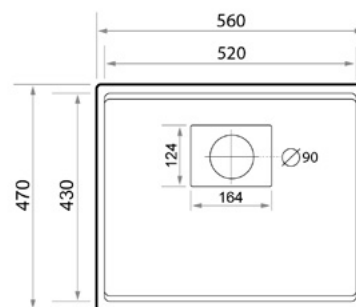

Dostępne akcesoria dodatkowe:



Osprzęt automatyczny



Czarna maskownica "R"



Zwijany ociekacz czarny mat



Wkładka ociekowa



Deska kuchenna bukowa lub dębowa



Deska kuchenna HPL



do szafki od 60cm



40 lat gwarancji



BrandeTec+



odporność na zarysowania



odporność na przebarwienia



odporność na wysoką temperaturę



odporność na zabrudzenia



odporność na uderzenia



odporność na szok termiczny



łatwe w czyszczeniu



nie traci koloru



komora XXL



system Level



Zone

Na wizualizacji model Zone 580-60

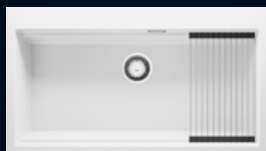

Zone 900-90

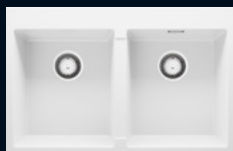

Zone Dual 780-80

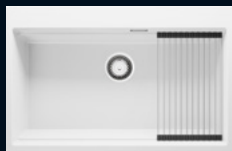

Zone 780-80

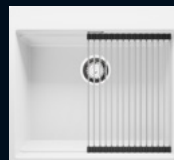

Zone Max 580-60



Zone Pocket
580-60

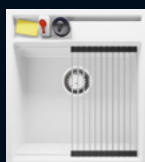

Zone Pocket
480-50

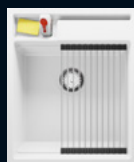

Zone Pocket
430-45

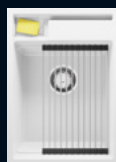

Zone Pocket
380-40

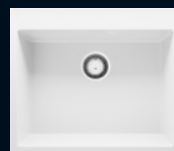

Zone 590-60

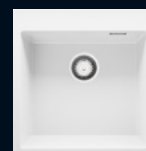

Zone 490-50

◆● Zone 900-90



	Black	B#MO9.KC.SM.001
	Black Metallic	B#MO9.KM.SM.001
	Graphite	B#MO9.KG.SM.001
	Grey	B#MO9.KS.SM.001
	Beige	B#MO9.KB.SM.001
	White	B#MO9.KW.SM.001

Cena katalogowa od:
1 949,99 PLN

W zestawie:



Osprzęt manualny



Zwijany ociekacz chrom

Dane techniczne

Rodzaj:	zlewozmywak nablatowy
Rozmiar szafki:	od 90 cm
Wymiary zewnętrzne:	900 x 500 mm
Wymiary komory:	840 x 400 x 200 mm
Odwracalny:	Nie
Liczba otworów:	7 podfrezowanych otworów

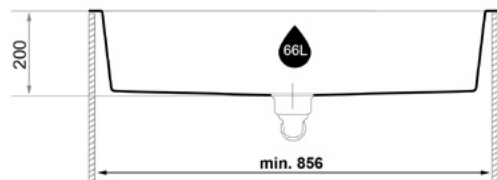
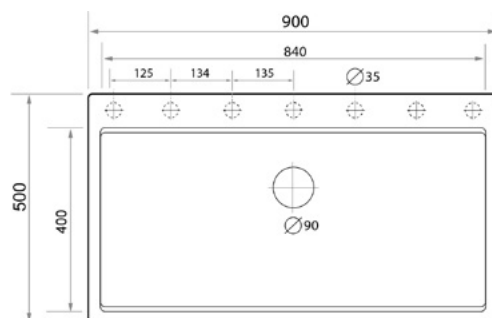

Dostępne akcesoria dodatkowe:



Osprzęt automatyczny



Opcje osprzętu

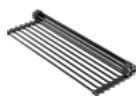

Zwijany ociekacz czarny mat



Wkładka ociekowa



Deska kuchenna bukowa lub dębowa



Deska kuchenna HPL



do szafki od 90cm



40 lat gwarancji



BrandeTec+



odporność na zarysowania



odporność na przebarwienia



odporność na wysoką temperaturę



odporność na zabrudzenia



odporność na uderzenia



odporność na szok termiczny



łatwe w czyszczeniu



nie traci koloru



elastyczność projektowania



komora XXL



system Level

◆● Zone Dual 780-80



	Black	B#MO8.KC.SM.001
	Black Metallic	B#MO8.KM.SM.001
	Graphite	B#MO8.KG.SM.001
	Grey	B#MO8.KS.SM.001
	Beige	B#MO8.KB.SM.001
	White	B#MO8.KW.SM.001

Cena katalogowa od:
1 499,99 PLN

W zestawie:



Osprzęt manualny

Dane techniczne

Rodzaj:	zlewozmywak nabladowy
Rozmiar szafki:	od 80 cm
Wymiary zewnętrzne:	780 x 500 mm
Wymiary komory:	345 x 400 x 190 mm
Odwracalny:	Nie
Liczba otworów:	5 podfrezowanych otworów

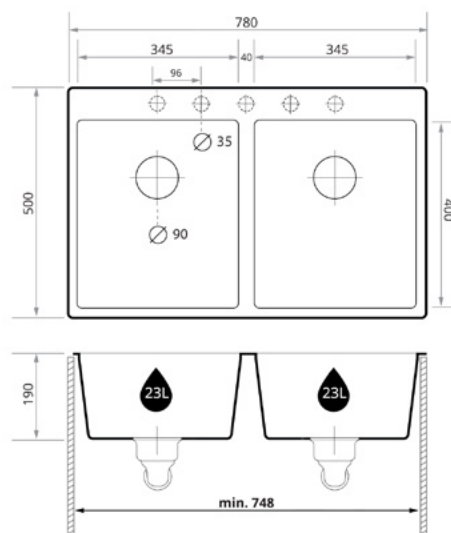

Dostępne akcesoria dodatkowe:



Osprzęt automatyczny



Opcje osprzętu



do szafki od 80 cm



40 lat gwarancji



BrandeTec+



odporność na zarysowania



odporność na przebarwienia



odporność na wysoką temperaturę



odporność na zabrudzenia



odporność na uderzenia



odporność na szok termiczny



łatwe w czyszczeniu



nie traci koloru



komora XXL

◆● Zone 780-80



	Black	B#MOE.KC.SM.001
	Black Metallic	B#MOE.KM.SM.001
	Graphite	B#MOE.KG.SM.001
	Grey	B#MOE.KS.SM.001
	Beige	B#MOE.KB.SM.001
	White	B#MOE.KW.SM.001

Cena katalogowa od:
1 599,99 PLN

W zestawie:



Osprzęt manualny



Zwijany ociekacz chrom

Dane techniczne

Rodzaj:	zlewozmywak nablatowy
Rozmiar szafki:	od 80 cm
Wymiary zewnętrzne:	780 x 500 mm
Wymiary komory:	740 x 400 x 200 mm
Odwracalny:	Nie
Liczba otworów:	7 podfrezowanych otworów

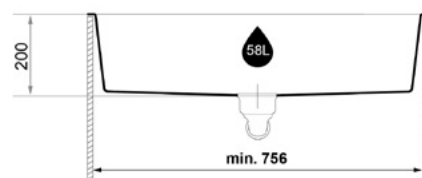
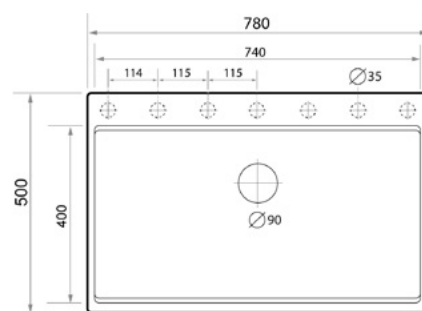

Dostępne akcesoria dodatkowe:



Osprzęt automatyczny



Opcje osprzętu



Zwijany ociekacz czarny mat



Wkładka ociekowa



Deska kuchenna bukowa lub dębowa



Deska kuchenna HPL



do szafki od 80cm



40 lat gwarancji



BrandeTec+



odporność na zarysowania



odporność na przebarwienia



odporność na wysoką temperaturę



odporność na zabrudzenia



odporność na uderzenia



odporność na szok termiczny



łatwe w czyszczeniu



nie traci koloru



elastyczność projektowania



komora XXL



system Level



◆● Zone Pocket 580-60



Cena katalogowa od:
1 699,99 PLN

W zestawie:



Osprzęt manualny



Zwijany ociekacz chrom

Dane techniczne

Rodzaj:	zlewozmywak nablatowy
Rozmiar szafki:	od 60 cm
Wymiary zewnętrzne:	580 x 530 mm
Wymiary komory:	540 x 400 x 200 mm
Odwracalny:	Nie
Liczba otworów:	4 podfrezowane otwory

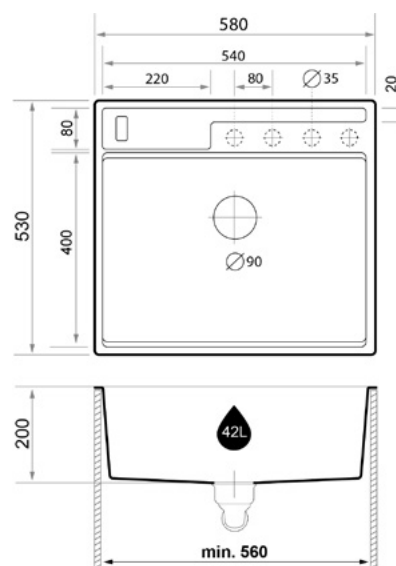

Dostępne akcesoria dodatkowe:



Osprzęt automatyczny



Opcje osprzętu



Zwijany ociekacz czarny mat



Wkładka ociekowa



Deska kuchenna bukowa lub dębowa



Deska kuchenna HPL



do szafki od 60cm



40 lat gwarancji



BrandeTec+



odporność na zarysowania



odporność na przebarwienia



odporność na wysoką temperaturę



odporność na zabrudzenia



odporność na uderzenia



odporność na szok termiczny



łatwe w czyszczeniu



nie traci koloru



elastyczność projektowania



komora XXL



komora MAX



system Level

◆● Zone Max 580-60



Cena katalogowa od:
1 599,99 PLN

W zestawie:



Osprzęt manualny



Zwijany ociekacz chrom

Dane techniczne

Rodzaj:	zlewozmywak nablatowy
Rozmiar szafki:	od 60 cm
Wymiary zewnętrzne:	580 x 530 mm
Wymiary komory:	540 x 430 x 210 mm
Odwracalny:	Nie
Liczba otworów:	5 podfrezowanych otworów

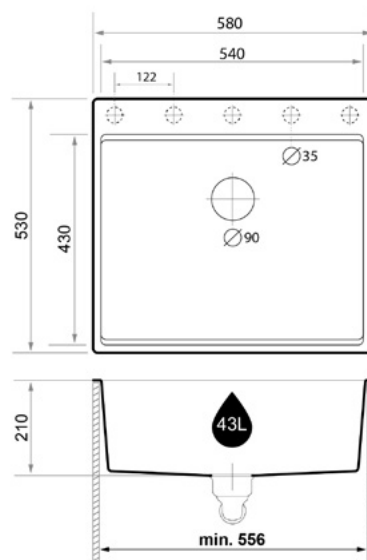

Dostępne akcesoria dodatkowe:



Osprzęt automatyczny



Opcje osprzętu



Zwijany ociekacz czarny mat



Wkładka ociekowa



Deska kuchenna bukowa lub dębowa



Deska kuchenna HPL



do szafki od 60cm



40 lat gwarancji



BrandeTec+



odporność na zarysowania



odporność na



odporność na wysoką temperaturę



odporność na zabrudzenia



odporność na uderzenia



odporność na szok termiczny



łatwe w czyszczeniu



nie traci koloru



elastyczność projektowania



komora XXL



komora MAX



system Level

◆● Zone 590-60



	Black	B#MO6.KC.SM.001
	Black Metallic	B#MO6.KM.SM.001
	Graphite	B#MO6.KG.SM.001
	Grey	B#MO6.KS.SM.001
	Beige	B#MO6.KB.SM.001
	White	B#MO6.KW.SM.001

Cena katalogowa od:
1 349,99 PLN

W zestawie:



Osprzęt manualny

Dane techniczne

Rodzaj:	zlewozmywak nablutowy
Rozmiar szafki:	od 60 cm
Wymiary zewnętrzne:	590 x 500 mm
Wymiary komory:	540 x 400 x 190 mm
Odwracalny:	Nie
Liczba otworów:	5 podfrezowanych otworów

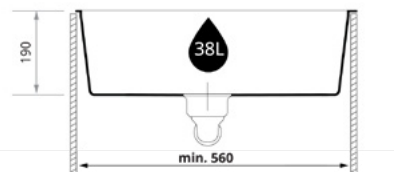
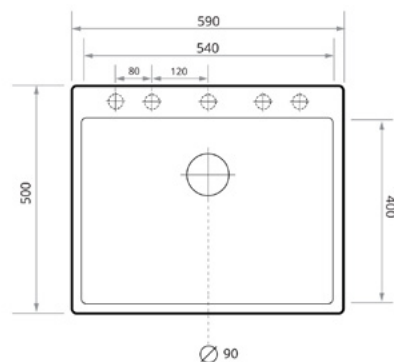

Dostępne akcesoria dodatkowe:



Osprzęt automatyczny



Opcje osprzętu



Deska kuchenna bukowa lub dębowa



Deska kuchenna HPL



do szafki od 60cm



40 lat gwarancji



BrandTec+



odporność na zarysowania



odporność na przebarwienia



odporność na wysoką temperaturę



odporność na zabrudzenia



odporność na uderzenia



odporność na szok termiczny



łatwe w czyszczeniu



nie traci koloru



elastyczność projektowania



komora XXL



◆● Zone 490-50



Cena katalogowa od:
1 299,99 PLN

W zestawie:



Dane techniczne

Rodzaj:	zlewozmywak nablutowy
Rozmiar szafki:	od 50 cm
Wymiary zewnętrzne:	490 x 500 mm
Wymiary komory:	440 x 400 x 190 mm
Odwracalny:	Nie
Liczba otworów:	5 podfrezowanych otworów

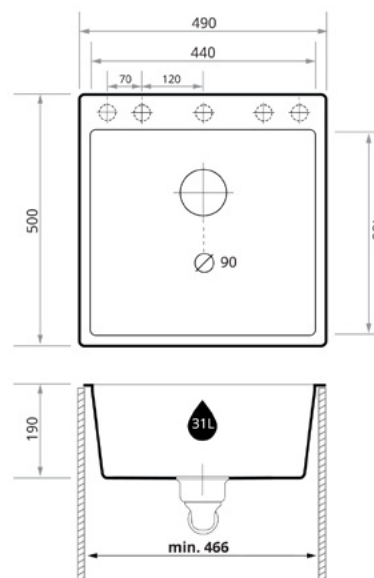

Dostępne akcesoria dodatkowe:



do szafki od 50cm



40 lat gwarancji



BrandTec+



odporność na zarysowania



odporność na przebarwienia



odporność na wysoką temperaturę



odporność na zabrudzenia



odporność na uderzenia



odporność na szok termiczny



łatwe w czyszczeniu



nie traci koloru



elastyczność projektowania



komora XXL



✦ **Whip**

◆● Whip Max 580-60



Cena katalogowa od:
1 599,99 PLN

W zestawie:



Osprzęt manualny



Zwijany ociekacz chrom

Dane techniczne

Rodzaj:	zlewozmywak nablatowy
Rozmiar szafki:	od 60 cm
Wymiary zewnętrzne:	580 x 530 mm
Wymiary komory:	540 x 410 x 200 mm
Odwracalny:	Nie
Liczba otworów:	5 podfrezowanych otworów

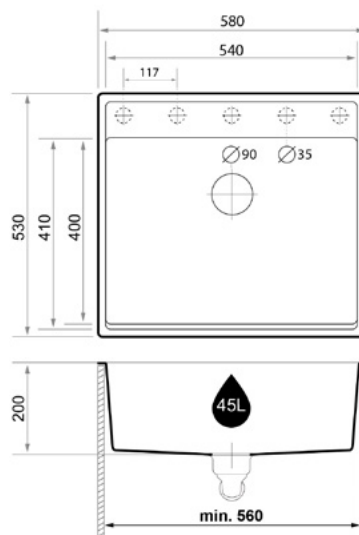

Dostępne akcesoria dodatkowe:



Osprzęt automatyczny



Opcje osprzętu



Zwijany ociekacz czarny mat



Wkładka ociekowa



Deska kuchenna bukowa lub dębowa



Deska kuchenna HPL



do szafki od 60cm



40 lat gwarancji



BrandeTec+



odporność na zarysowania



odporność na przebarwienia



odporność na wysoką temperaturę



odporność na zabrudzenia



odporność na uderzenia



odporność na szok termiczny



łatwe w czyszczeniu



nie traci koloru



elastyczność projektowania



komora XXL



komora MAX



system Level



✦ Swift Slim

Na wizualizacji model Swift Slim 580-60



Swift Slim 860-90



Swift Slim 760-80



Swift Slim 580-60

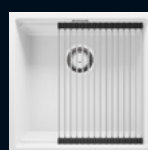

Swift Slim Grande
560-60



Swift Slim 460-50



Swift Slim 410-45



Swift Slim 360-40



Swift Slim Low Cut 760-80

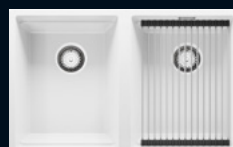

Swift Dual Slim 760-80

◆● Swift Slim 860-90



	Black	B#MPN.KC.SM.001
	Black Metallic	B#MPN.KM.SM.001
	Graphite	B#MPN.KG.SM.001
	Grey	B#MPN.KS.SM.001
	Beige	B#MPN.KB.SM.001
	White	B#MPN.KW.SM.001

Cena katalogowa od:
1 999,99 PLN

W zestawie:



Osprzęt manualny



Zwijany ociekacz chrom

Dane techniczne

Rodzaj:	zlewozmywak nablatowy
Rozmiar szafki:	od 90 cm
Wymiary zewnętrzne:	860 x 470 mm
Wymiary komory:	820 x 430 x 200 mm
Odwracalny:	Nie

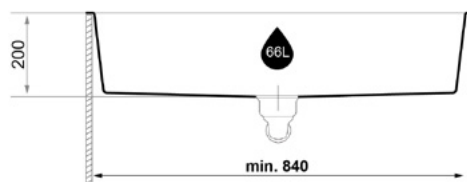
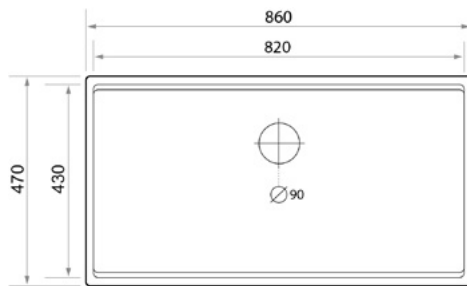

Dostępne akcesoria dodatkowe:



Osprzęt automatyczny



Opcje osprzętu



Zwijany ociekacz czarny mat



Wkładka ociekowa



Deska kuchenna bukowa lub dębowa



Deska kuchenna HPL



do szafki od 90cm



40 lat gwarancji



BrandeTec+



odporność na zarysowania



odporność na przebarwienia



odporność na wysoką temperaturę



odporność na zabrudzenia



odporność na uderzenia



odporność na szok termiczny



łatwe w czyszczeniu



nie traci koloru









komora XXL

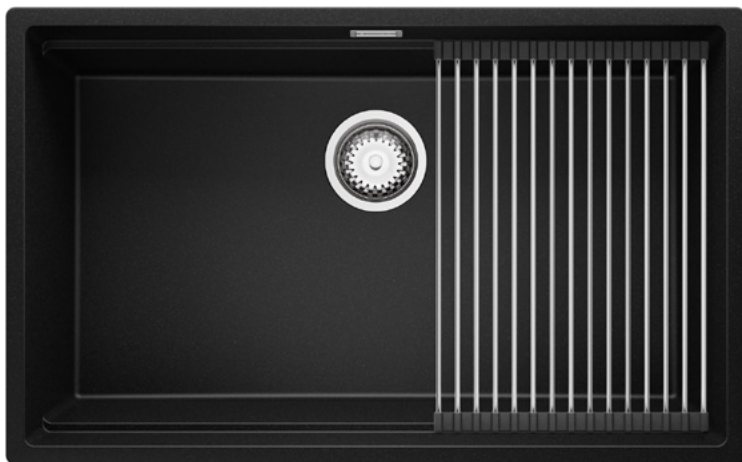

system Level

◆● Swift Slim 760-80



	Black	B#MP8.KC.SM.001
	Black Metallic	B#MP8.KM.SM.001
	Graphite	B#MP8.KG.SM.001
	Grey	B#MP8.KS.SM.001
	Beige	B#MP8.KB.SM.001
	White	B#MP8.KW.SM.001

Cena katalogowa od:
1 799,99 PLN

W zestawie:



Osprzęt manualny



Zwijany ociekacz chrom

Dane techniczne

Rodzaj:	zlewozmywak nablatowy
Rozmiar szafki:	od 80 cm
Wymiary zewnętrzne:	760 x 470 mm
Wymiary komory:	720 x 430 x 200 mm
Odwracalny:	Nie

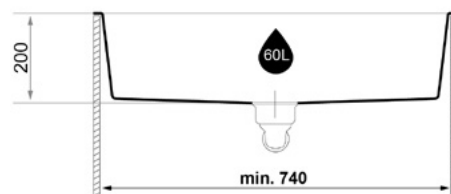
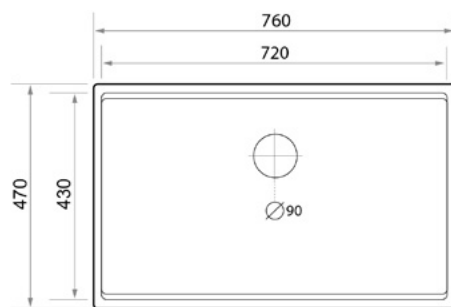

Dostępne akcesoria dodatkowe:



Osprzęt automatyczny



Opcje osprzętu



Zwijany ociekacz czarny mat



Wkładka ociekowa



Deska kuchenna bukowa lub dębowa



Deska kuchenna HPL



do szafki od 80cm



40 lat gwarancji



BrandeTec+



odporność na zarysowania



odporność na przebarwienia



odporność na wysoką temperaturę



odporność na zabrudzenia



odporność na uderzenia



odporność na szok termiczny



łatwe w czyszczeniu



nie traci koloru









komora XXL

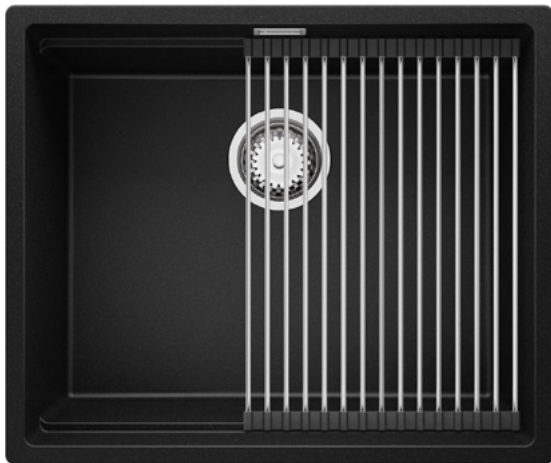

system Level

◆● Swift Slim 560-60



	Black	B#MP6.KC.SM.001
	Black Metallic	B#MP6.KM.SM.001
	Graphite	B#MP6.KG.SM.001
	Grey	B#MP6.KS.SM.001
	Beige	B#MP6.KB.SM.001
	White	B#MP6.KW.SM.001

W zestawie:



Osprzęt manualny



Zwijany ociekacz chrom

Cena katalogowa od:
1 499,99 PLN

Dane techniczne

Rodzaj:	zlewozmywak nablutowy
Rozmiar szafki:	od 60 cm
Wymiary zewnętrzne:	560 x 470 mm
Wymiary komory:	520 x 430 x 200 mm
Odwracalny:	Nie

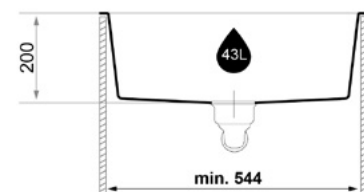
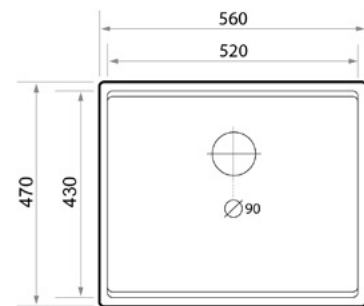

Dostępne akcesoria dodatkowe:



Osprzęt automatyczny



Opcje osprzętu



Zwijany ociekacz czarny mat



Wkładka ociekowa



Deska kuchenna bukowa lub dębowa



Deska kuchenna HPL



do szafki od 60cm



40 lat gwarancji



BrandeTec+



odporność na zarysowania



odporność na przebarwienia



odporność na wysoką temperaturę



odporność na zabrudzenia



odporność na uderzenia



odporność na szok termiczny



łatwe w czyszczeniu



nie traci koloru



komora XXL



system Level



◆● Swift Slim 410-45



Black B#MP4.KC.SM.001

Black Metallic B#MP4.KM.SM.001

Graphite B#MP4.KG.SM.001

Grey B#MP4.KS.SM.001

Beige B#MP4.KB.SM.001

White B#MP4.KW.SM.001

Cena katalogowa od:
1 249,99 PLN

W zestawie:



Osprzęt manualny



Zwijany ociekacz chrom

Dane techniczne

Rodzaj:	zlewozmywak nablatowy
Rozmiar szafki:	od 45 cm
Wymiary zewnętrzne:	410 x 470 mm
Wymiary komory:	370 x 430 x 200 mm
Odwracalny:	Nie

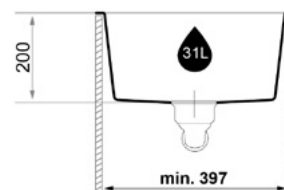
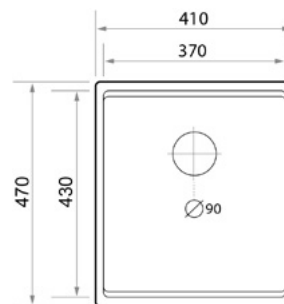

Dostępne akcesoria dodatkowe:



Osprzęt automatyczny



Opcje osprzętu



Zwijany ociekacz czarny mat



Wkładka ociekowa



Deska kuchenna bukowa lub dębowa



Deska kuchenna HPL



do szafki od 45cm



40 lat gwarancji



BrandeTec+



odporność na zarysowania



odporność na przebarwienia



odporność na wysoką temperaturę



odporność na zabrudzenia



odporność na uderzenia



odporność na szok termiczny



łatwe w czyszczeniu



nie traci koloru



system Level



✦ Solar Slim

Na wizualizacji model Swift Slim 760-80



Solar Slim 760-80



Solar Slim 660-70



Solar Slim 560-60

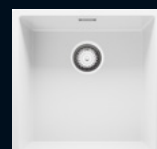

Solar Slim 460-50

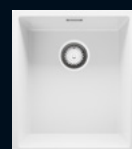

Solar Slim 410-45

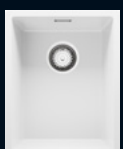

Solar Slim 360-40



Solar Slim 260-30

◆● Solar Slim 760-80



	Black	B#ML8.KC.SM.001
	Black Metallic	B#ML8.KM.SM.001
	Graphite	B#ML8.KG.SM.001
	Grey	B#ML8.KS.SM.001
	Beige	B#ML8.KB.SM.001
	White	B#ML8.KW.SM.001

Cena katalogowa od:
1 599,99 PLN

W zestawie:



Osprzęt manualny

Dane techniczne

Rodzaj:	zlewozmywak nablatowy
Rozmiar szafki:	od 80 cm
Wymiary zewnętrzne:	760 x 470 mm
Wymiary komory:	720 x 430 x 200 mm
Odwracalny:	Nie

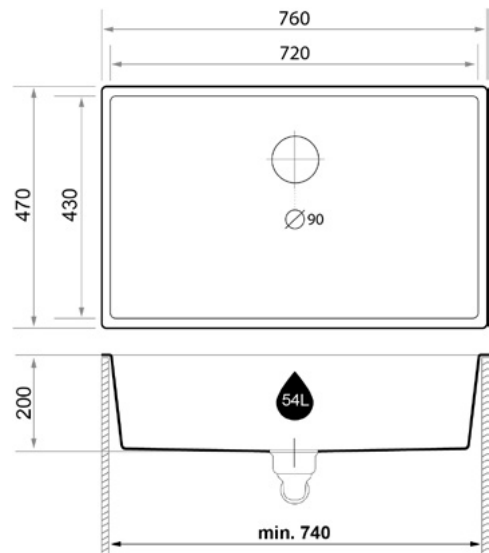

Dostępne akcesoria dodatkowe:



Osprzęt automatyczny



Opcje osprzętu



Deska kuchenna bukowa lub dębowa



Deska kuchenna HPL



do szafki od 80cm



40 lat gwarancji



BrandTec+



odporność na zarysowania



odporność na przebarwienia



odporność na wysoką temperaturę



odporność na zabrudzenia



odporność na uderzenia



odporność na szok termiczny









łatwe w czyszczeniu



nie traci koloru

◆● Solar Slim 660-70



	Black	B#ML7.KC.SM.001
	Black Metallic	B#ML7.KM.SM.001
	Graphite	B#ML7.KG.SM.001
	Grey	B#ML7.KS.SM.001
	Beige	B#ML7.KB.SM.001
	White	B#ML7.KW.SM.001

Cena katalogowa od:
1 549,99 PLN

W zestawie:



Osprzęt manualny

Dane techniczne

Rodzaj:	zlewozmywak nablatowy
Rozmiar szafki:	od 70 cm
Wymiary zewnętrzne:	660 x 470 mm
Wymiary komory:	620 x 430 x 200 mm
Odwracalny:	Nie

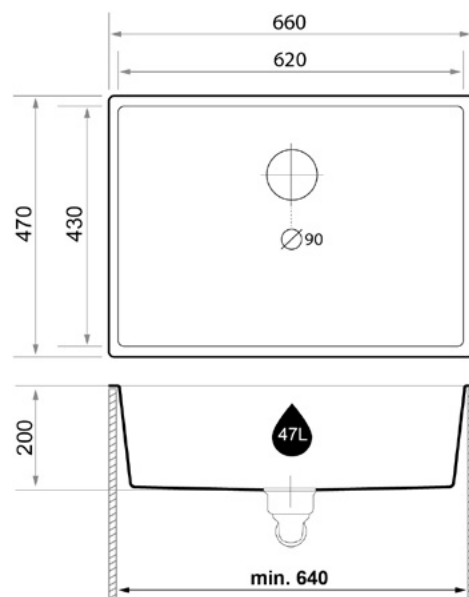

Dostępne akcesoria dodatkowe:



Osprzęt automatyczny



Opcje osprzętu



Deska kuchenna bukowa lub dębowa



Deska kuchenna HPL



do szafki od 70cm



40 lat gwarancji



BrandeTec+



odporność na zarysowania



odporność na przebarwienia



odporność na wysoką temperaturę



odporność na zabrudzenia



odporność na uderzenia



odporność na szok termiczny







łatwe w czyszczeniu



nie traci koloru

◆● Solar Slim 560-60



	Black	B#ML6.KC.SM.001
	Black Metallic	B#ML6.KM.SM.001
	Graphite	B#ML6.KG.SM.001
	Grey	B#ML6.KS.SM.001
	Beige	B#ML6.KB.SM.001
	White	B#ML6.KW.SM.001

Cena katalogowa od:
1 299,99 PLN

W zestawie:



Osprzęt
manualny

Dane techniczne

Rodzaj:	zlewozmywak nablatowy
Rozmiar szafki:	od 60 cm
Wymiary zewnętrzne:	560 x 470 mm
Wymiary komory:	520 x 430 x 200 mm
Odwracalny:	Nie

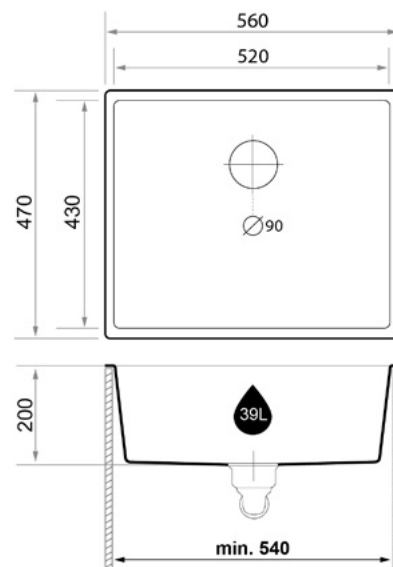

Dostępne akcesoria dodatkowe:



Osprzęt
automatyczny



Opcje osprzętu



Deska kuchenna
bukowa lub dębowa



Deska kuchenna
HPL



do szafki od 60cm



40 lat gwarancji



BrandeTec+



odporność na zarysowania



odporność na
przebarwienia



odporność na wysoką
temperaturę



odporność na
zabrudzenia



odporność na uderzenia



odporność na
szok termiczny



łatwe w czyszczeniu



nie traci koloru

◆● Solar Slim 460-50



	Black	B#ML5.KC.SM.001
	Black Metallic	B#ML5.KM.SM.001
	Graphite	B#ML5.KG.SM.001
	Grey	B#ML5.KS.SM.001
	Beige	B#ML5.KB.SM.001
	White	B#ML5.KW.SM.001

Cena katalogowa od:
1 249,99 PLN

W zestawie:



Osprzęt manualny

Dane techniczne

Rodzaj:	zlewozmywak nablatowy
Rozmiar szafki:	od 50 cm
Wymiary zewnętrzne:	460 x 470 mm
Wymiary komory:	420 x 430 x 200 mm
Odwracalny:	Nie

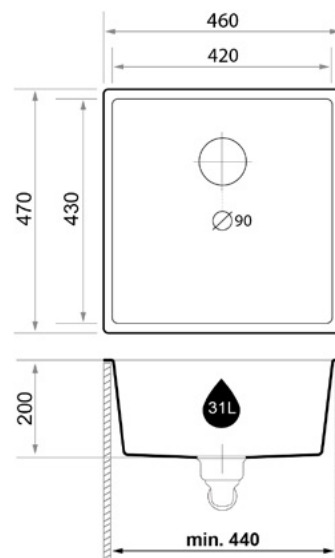

Dostępne akcesoria dodatkowe:



Osprzęt automatyczny



Opcje osprzętu



Deska kuchenna bukowa lub dębowa



Deska kuchenna HPL

- do szafki od 50cm
- 40 lat gwarancji
- BrandeTec+
- odporność na zarysowania
- odporność na przebarwienia
- odporność na wysoką temperaturę
- odporność na zabrudzenia
- odporność na uderzenia
- odporność na szok termiczny
- łatwe w czyszczeniu
- nie traci koloru

◆● Solar Slim 410-45



	Black	B#ML4.KC.SM.001
	Black Metallic	B#ML4.KM.SM.001
	Graphite	B#ML4.KG.SM.001
	Grey	B#ML4.KS.SM.001
	Beige	B#ML4.KB.SM.001
	White	B#ML4.KW.SM.001

Cena katalogowa od:
1 149,99 PLN

W zestawie:



Osprzęt
manualny

Dane techniczne

Rodzaj:	zlewozmywak nablatowy
Rozmiar szafki:	od 45 cm
Wymiary zewnętrzne:	410 x 470 mm
Wymiary komory:	370 x 430 x 200 mm
Odwracalny:	Nie

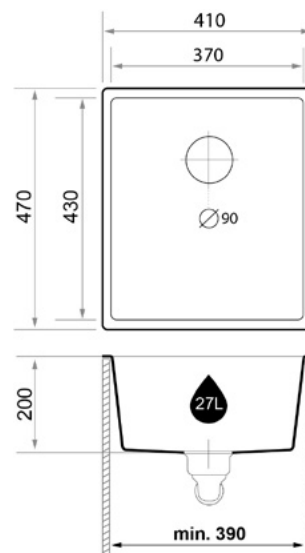

Dostępne akcesoria dodatkowe:



Osprzęt
automatyczny



Opcje osprzętu



Deska kuchenna
bukowa lub dębowa



Deska kuchenna
HPL



do szafki od 45cm



40 lat gwarancji



BrandTec+



odporność na zarysowania



odporność na
przebarwienia



odporność na wysoką
temperaturę



odporność na
zabrudzenia



odporność na uderzenia



odporność na
szok termiczny



łatwe w czyszczeniu



nie traci koloru

◆● Solar Slim 360-40



Black

B#MLF.KC.SM.001



Black Metallic

B#MLF.KM.SM.001



Graphite

B#MLF.KG.SM.001



Grey

B#MLF.KS.SM.001



Beige

B#MLF.KB.SM.001



White

B#MLF.KW.SM.001

Cena katalogowa od:
1 099,99 PLN

W zestawie:



Osprzęt
manualny

Dane techniczne

Rodzaj:	zlewozmywak nablatowy
Rozmiar szafki:	od 40 cm
Wymiary zewnętrzne:	360 x 470 mm
Wymiary komory:	320 x 430 x 200 mm
Odwracalny:	Nie

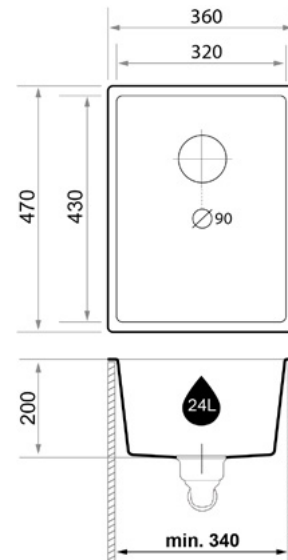

Dostępne akcesoria dodatkowe:



Osprzęt
automatyczny



Opcje osprzętu



Deska kuchenna
bukowa lub dębowa



Deska kuchenna
HPL



do szafki od 40cm



40 lat gwarancji



BrandeTec+



odporność na zarysowania



odporność na
przebarwienia



odporność na wysoką
temperaturę



odporność na zabrudzenia



odporność na uderzenia



odporność na
szok termiczny



łatwe w czyszczeniu



nie traci koloru

◆● Solar Slim 260-30



Black B#ML3.KC.SM.001

Black Metallic B#ML3.KM.SM.001

Graphite B#ML3.KG.SM.001

Grey B#ML3.KS.SM.001

Beige B#ML3.KB.SM.001

White B#ML3.KW.SM.001

Cena katalogowa od:
1 049,99 PLN

W zestawie:



Osprzęt
manualny

Dane techniczne

Rodzaj:	zlewozmywak nablatowy
Rozmiar szafki:	od 30 cm
Wymiary zewnętrzne:	260 x 470 mm
Wymiary komory:	220 x 430 x 200 mm
Odwracalny:	Nie

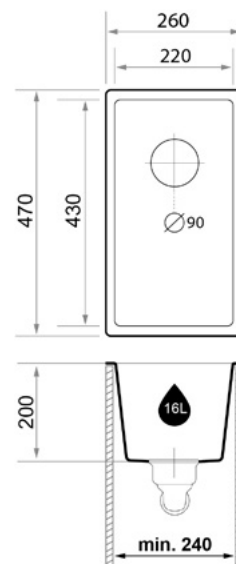

Dostępne akcesoria dodatkowe:



Osprzęt
automatyczny



Opcje osprzętu



Deska kuchenna
bukowa lub dębowa



Deska kuchenna
HPL



do szafki od 30cm



40 lat gwarancji



BrandTec+



odporność na zarysowania



odporność na
przebarwienia



odporność na wysoką
temperaturę



odporność na
zabrudzenia



odporność na uderzenia



odporność na
szok termiczny



łatwe w czyszczeniu



nie traci koloru



Joy

Na wizualizacji model Joy Max 440-45

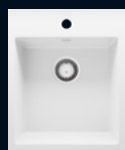

Joy Max 440-45

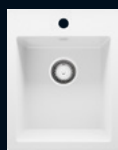





Joy 400-40



Joy Rond 500-45

✦● Joy Max 440-45



	Black	B#MY4.KC.SM.001
	Black Metallic	B#MY4.KM.SM.001
	Graphite	B#MY4.KG.SM.001
	Grey	B#MY4.KS.SM.001
	Beige	B#MY4.KB.SM.001
	White	B#MY4.KW.SM.001

Cena katalogowa od:
1 199,99 PLN

W zestawie:



Osprzęt manualny

Dane techniczne

Rodzaj:	zlewozmywak nablatowy
Rozmiar szafki:	od 45 cm
Wymiary zewnętrzne:	440 x 530 mm
Wymiary komory:	390 x 400 x 190 mm
Odwracalny:	Nie
Liczba otworów:	1+2 podfrezowane otwory

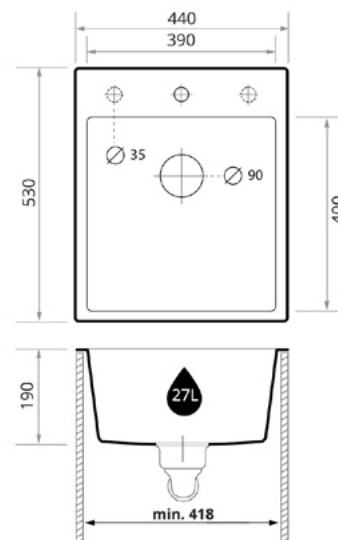

Dostępne akcesoria dodatkowe:



Osprzęt automatyczny



Opcje osprzętu



Deska kuchenna bukowa lub dębowa



Deska kuchenna HPL



do szafki od 45cm



40 lat gwarancji



BrandeTec+



odporność na zarysowania



odporność na przebarwienia



odporność na wysoką temperaturę



odporność na zabrudzenia



odporność na uderzenia



odporność na szok termiczny



łatwe w czyszczeniu



nie traci koloru



elastyczność projektowania

MAX komora MAX

◆● Joy 400-40



	Black	B#MYL.KC.SM.001
	Black Metallic	B#MYL.KM.SM.001
	Graphite	B#MYL.KG.SM.001
	Grey	B#MYL.KS.SM.001
	Beige	B#MYL.KB.SM.001
	White	B#MYL.KW.SM.001

Cena katalogowa od:
1 049,99 PLN

W zestawie:



Osprzęt manualny

Dane techniczne

Rodzaj:	zlewozmywak nablutowy
Rozmiar szafki:	od 40 cm
Wymiary zewnętrzne:	400 x 500 mm
Wymiary komory:	335 x 370 x 190 mm
Odwracalny:	Nie
Liczba otworów:	1+2 podfrezowane otwory

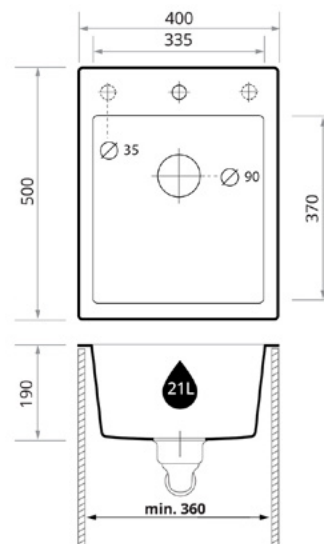

Dostępne akcesoria dodatkowe:



Osprzęt automatyczny



Opcje osprzętu



Deska kuchenna bukowa lub dębowa



Deska kuchenna HPL



do szafki od 40cm



40 lat gwarancji



BrandeTec+



odporność na zarysowania



odporność na przebarwienia



odporność na wysoką temperaturę



odporność na zabrudzenia



odporność na uderzenia



odporność na szok termiczny



łatwe w czyszczeniu



nie traci koloru



elastyczność projektowania

◆● Joy Rond 500-45



	Black	B#MA4.KC.SM.001
	Black Metallic	B#MA4.KM.SM.001
	Graphite	B#MA4.KG.SM.001
	Grey	B#MA4.KS.SM.001
	Beige	B#MA4.KB.SM.001
	White	B#MA4.KW.SM.001

Cena katalogowa od:
1 049,99 PLN

W zestawie:



Osprzęt
manualny

Dane techniczne

Rodzaj:	zlewozmywak nablutowy
Rozmiar szafki:	od 45 cm
Wymiary zewnętrzne:	500 x 500 mm
Wymiary komory:	400 x 400 x 200 mm
Odwracalny:	Nie
Liczba otworów:	1+2 podfrezowane otwory

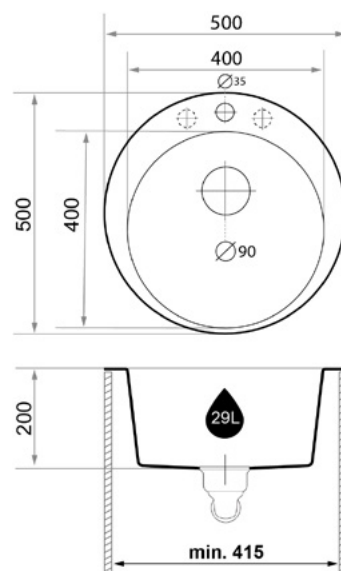

Dostępne akcesoria dodatkowe:



Osprzęt
automatyczny



Opcje osprzętu



do szafki od 45cm



40 lat gwarancji



BrandeTec+



odporność na zarysowania



odporność na
przebarwienia



odporność na wysoką
temperaturę



odporność na
zabrudzenia



odporność na uderzenia



odporność na
szok termiczny



łatwe w czyszczeniu



nie traci koloru



elastyczność
projektowania



✦ Shape

Na wizualizacji model Shape 900-60

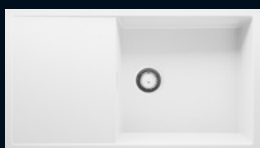

Shape 900-60



Shape Dual 900-60

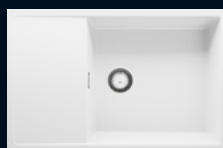

Shape 780-60



Shape Dual 780-60

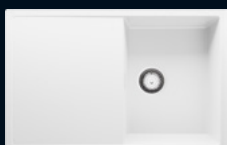



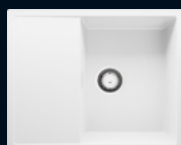



Shape 780-45



Shape 620-45

◆● Shape 900-60



	Black	B#MI9.KC.SM.001
	Black Metallic	B#MI9.KM.SM.001
	Graphite	B#MI9.KG.SM.001
	Grey	B#MI9.KS.SM.001
	Beige	B#MI9.KB.SM.001
	White	B#MI9.KW.SM.001

Cena katalogowa od:
1 649,99 PLN

W zestawie:



Osprzęt
manualny

Dane techniczne

Rodzaj:	zlewozmywak nablatowy
Rozmiar szafki:	od 60 cm
Wymiary zewnętrzne:	900 x 500 mm
Wymiary komory:	475 x 450 x 190 mm
Odwracalny:	Tak
Liczba otworów:	4 podfrezowane otwory

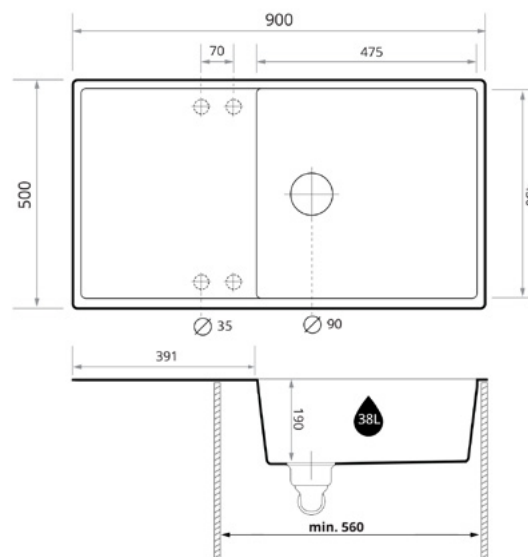

Dostępne akcesoria dodatkowe:



Osprzęt
automatyczny



Opcje osprzętu



do szafki od 60cm



40 lat gwarancji



BrandTec+



odporność na zarysowania



odporność na przebarwienia



odporność na wysoką temperaturę



odporność na zabrudzenia



odporność na uderzenia



odporność na szok termiczny



łatwe w czyszczeniu



nie traci koloru









elastyczność projektowania



komora XXL

◆● Shape Dual 900-60



	Black	B#MID.KC.SM.001
	Black Metallic	B#MID.KM.SM.001
	Graphite	B#MID.KG.SM.001
	Grey	B#MID.KS.SM.001
	Beige	B#MID.KB.SM.001
	White	B#MID.KW.SM.001

Cena katalogowa od:
1 649,99 PLN

W zestawie:



Osprzęt manualny

Dane techniczne

Rodzaj:	zlewozmywak nablutowy
Rozmiar szafki:	od 60 cm
Wymiary zewnętrzne:	900 x 500 mm
Wymiary komory:	340 x 450 x 190 mm
Odwracalny:	Tak
Liczba otworów:	4 podfrezowane otwory

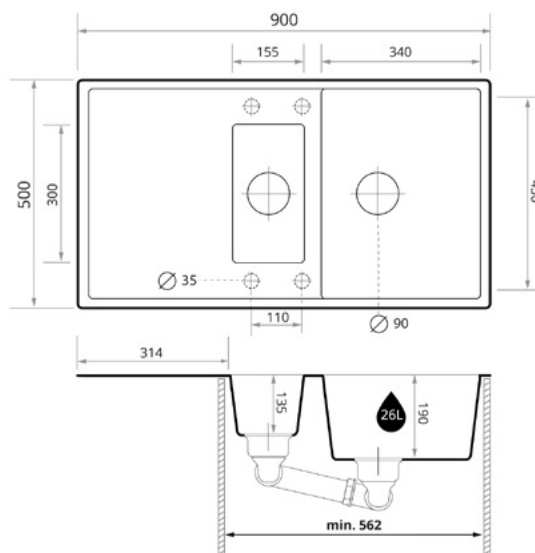

Dostępne akcesoria dodatkowe:



Osprzęt automatyczny



Opcje osprzętu



do szafki od 60cm



40 lat gwarancji



BrandTec+



odporność na zarysowania



odporność na przebarwienia



odporność na wysoką temperaturę



odporność na zabrudzenia



odporność na uderzenia



odporność na szok termiczny



łatwe w czyszczeniu









nie traci koloru



elastyczność projektowania

◆● Shape 780-60



	Black	B#MIX.KC.SM.001
	Black Metallic	B#MIX.KM.SM.001
	Graphite	B#MIX.KG.SM.001
	Grey	B#MIX.KS.SM.001
	Beige	B#MIX.KB.SM.001
	White	B#MIX.KW.SM.001

Cena katalogowa od:
1 549,99 PLN

W zestawie:



Osprzęt manualny

Dane techniczne

Rodzaj:	zlewozmywak nablutowy
Rozmiar szafki:	od 60 cm
Wymiary zewnętrzne:	780 x 500 mm
Wymiary komory:	475 x 450 x 190 mm
Odwracalny:	Tak
Liczba otworów:	4 podfrezowane otwory

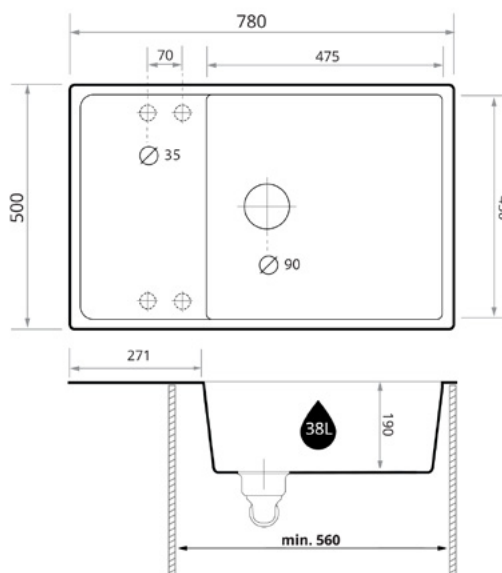

Dostępne akcesoria dodatkowe:



Osprzęt automatyczny



Opcje osprzętu



do szafki od 60cm



40 lat gwarancji



BrandTec+



odporność na zarysowania



odporność na przebarwienia



odporność na wysoką temperaturę



odporność na zabrudzenia



odporność na uderzenia



odporność na szok termiczny



łatwe w czyszczeniu









nie traci koloru



elastyczność projektowania

◆● Shape Dual 780-60



	Black	B#MIE.KC.SM.001
	Black Metallic	B#MIE.KM.SM.001
	Graphite	B#MIE.KG.SM.001
	Grey	B#MIE.KS.SM.001
	Beige	B#MIE.KB.SM.001
	White	B#MIE.KW.SM.001

Cena katalogowa od:
1 549,99 PLN

W zestawie:



Osprzęt
manualny

Dane techniczne

Rodzaj:	zlewozmywak nablutowy
Rozmiar szafki:	od 60 cm
Wymiary zewnętrzne:	780 x 500 mm
Wymiary komory:	340 x 450 x 190 mm
Odwracalny:	Tak
Liczba otworów:	4 podfrezowane otwory

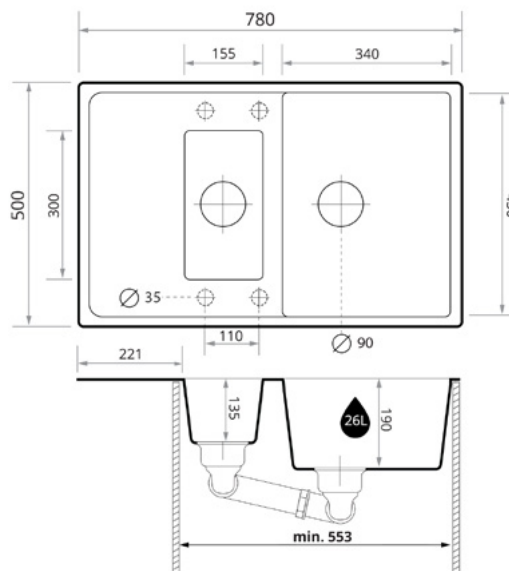

Dostępne akcesoria dodatkowe:



Osprzęt
automatyczny



Opcje osprzętu



do szafki od 60cm



40 lat gwarancji



BrandeTec+



odporność na zarysowania



odporność na przebarwienia



odporność na wysoką temperaturę



odporność na zabrudzenia



odporność na uderzenia



odporność na szok termiczny



łatwe w czyszczeniu









nie traci koloru



elastyczność projektowania

◆● Shape 780-45



	Black	B#MI7.KC.SM.001
	Black Metallic	B#MI7.KM.SM.001
	Graphite	B#MI7.KG.SM.001
	Grey	B#MI7.KS.SM.001
	Beige	B#MI7.KB.SM.001
	White	B#MI7.KW.SM.001

Cena katalogowa od:
1 449,99 PLN

W zestawie:



Osprzęt manualny

Dane techniczne

Rodzaj:	zlewozmywak nablatowy
Rozmiar szafki:	od 45 cm
Wymiary zewnętrzne:	780 x 500 mm
Wymiary komory:	340 x 450 x 190 mm
Odwracalny:	Tak
Liczba otworów:	4 podfrezowane otwory

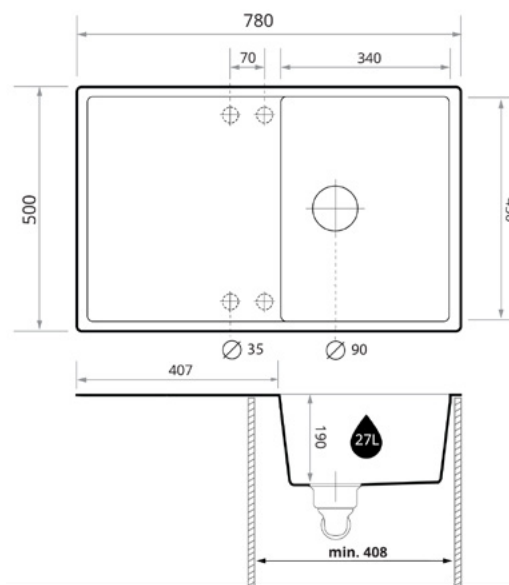

Dostępne akcesoria dodatkowe:



Osprzęt automatyczny



Opcje osprzętu



do szafki od 45cm



40 lat gwarancji



BrandTec+



odporność na zarysowania



odporność na przebarwienia



odporność na wysoką temperaturę



odporność na zabrudzenia



odporność na uderzenia



odporność na szok termiczny



łatwe w czyszczeniu



nie traci koloru



elastyczność projektowania



◆● Shape 620-45



W zestawie:



Osprzęt manualny

Dane techniczne

Rodzaj:	zlewozmywak nabladowy
Rozmiar szafki:	od 45 cm
Wymiary zewnętrzne:	620 x 500 mm
Wymiary komory:	340 x 450 x 190 mm
Odwracalny:	Tak
Liczba otworów:	4 podfrezowane otwory

Dostępne akcesoria dodatkowe:



Osprzęt automatyczny



Opcje osprzętu

	Black	B#MI6.KC.SM.001
	Black Metallic	B#MI6.KM.SM.001
	Graphite	B#MI6.KG.SM.001
	Grey	B#MI6.KS.SM.001
	Beige	B#MI6.KB.SM.001
	White	B#MI6.KW.SM.001

Cena katalogowa od:
1 349,99 PLN

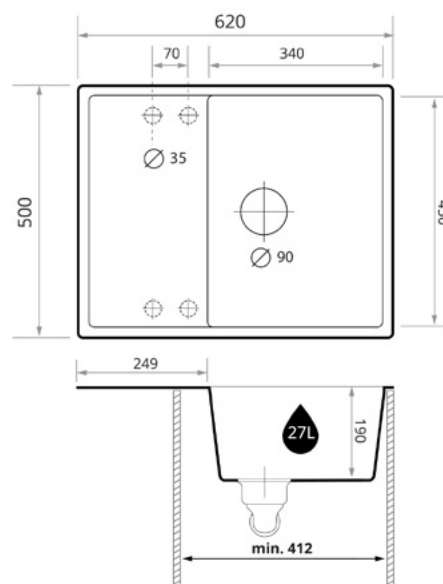

do szafki od 45cm



40 lat gwarancji



BrandTec+



odporność na zarysowania



odporność na przebarwienia



odporność na wysoką temperaturę



odporność na zabrudzenia



odporność na uderzenia



odporność na szok termiczny



łatwe w czyszczeniu



nie traci koloru



elastyczność projektowania



Lotus

Na wizualizacji model Lotus 900-60



Lotus 900-60



Lotus Dual 780-80



Lotus 780-60

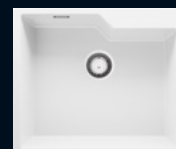

Lotus 590-60

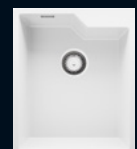

Lotus Max 440-45

◆● Lotus 900-60



	Black	B#MR9.KC.SM.001
	Black Metallic	B#MR9.KM.SM.001
	Graphite	B#MR9.KG.SM.001
	Grey	B#MR9.KS.SM.001
	Beige	B#MR9.KB.SM.001
	White	B#MR9.KW.SM.001

Cena katalogowa od:
1 499,99 PLN

W zestawie:



Osprzęt manualny

Dane techniczne

Rodzaj:	zlewozmywak nabladowy
Rozmiar szafki:	od 60 cm
Wymiary zewnętrzne:	900 x 500 mm
Wymiary komory:	525 x 450 x 200 mm
Odwracalny:	Tak
Liczba otworów:	4 podfrezowane otwory

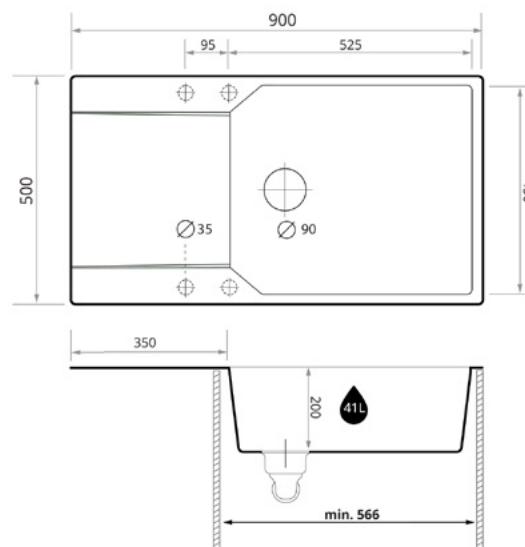

Dostępne akcesoria dodatkowe:



Osprzęt automatyczny



Opcje osprzętu



do szafki od 60cm



40 lat gwarancji



BrandTec+



odporność na zarysowania



odporność na przebarwienia



odporność na wysoką temperaturę



odporność na zabrudzenia



odporność na uderzenia



odporność na szok termiczny



łatwe w czyszczeniu



nie traci koloru



elastyczność projektowania



komora XXL

◆● Lotus Dual 780-80

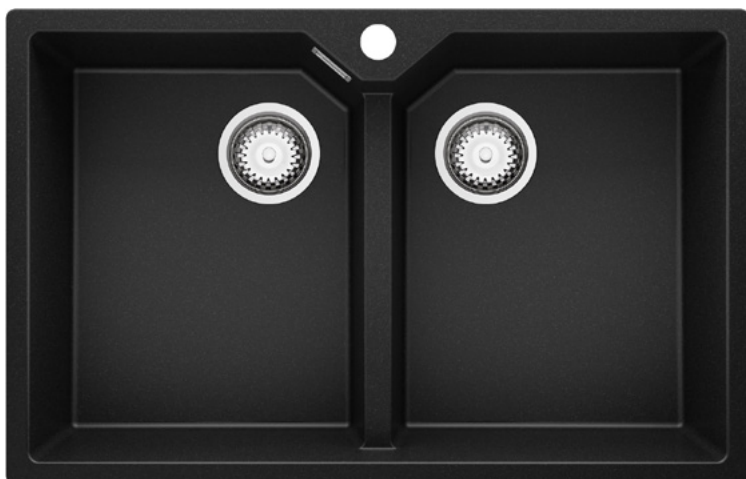

	Black	B#MRT.KC.SM.001
	Black Metallic	B#MRT.KM.SM.001
	Graphite	B#MRT.KG.SM.001
	Grey	B#MRT.KS.SM.001
	Beige	B#MRT.KB.SM.001
	White	B#MRT.KW.SM.001

Cena katalogowa od:
1 499,99 PLN

W zestawie:



Osprzęt manualny

Dane techniczne

Rodzaj:	zlewozmywak nablatowy
Rozmiar szafki:	od 80 cm
Wymiary zewnętrzne:	780 x 500 mm
Wymiary komory:	357 x 450 x 190 mm
Odwracalny:	Nie
Liczba otworów:	1

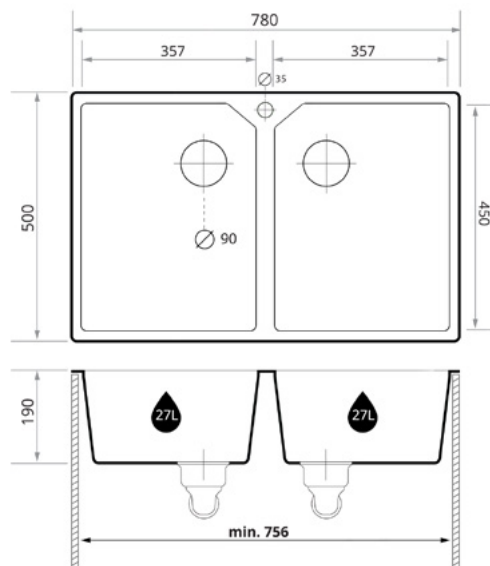

Dostępne akcesoria dodatkowe:



Osprzęt automatyczny



Opcje osprzętu

-  do szafki od 80cm
-  40 lat gwarancji
-  BrandeTec+
-  odporność na zarysowania
-  odporność na przebarwienia
-  odporność na wysoką temperaturę
-  odporność na zabrudzenia
-  odporność na uderzenia
-  odporność na szok termiczny
-  łatwe w czyszczeniu
-  nie traci koloru

 komora XXL

◆● Lotus 780-60



	Black	B#MRX.KC.SM.001
	Black Metallic	B#MRX.KM.SM.001
	Graphite	B#MRX.KG.SM.001
	Grey	B#MRX.KS.SM.001
	Beige	B#MRX.KB.SM.001
	White	B#MRX.KW.SM.001

Cena katalogowa od:
1 299,99 PLN

W zestawie:



Osprzęt manualny

Dane techniczne

Rodzaj:	zlewozmywak nablatowy
Rozmiar szafki:	od 60 cm
Wymiary zewnętrzne:	780 x 500 mm
Wymiary komory:	525 x 450 x 190 mm
Odwracalny:	Tak
Liczba otworów:	4 podfrezowane otwory

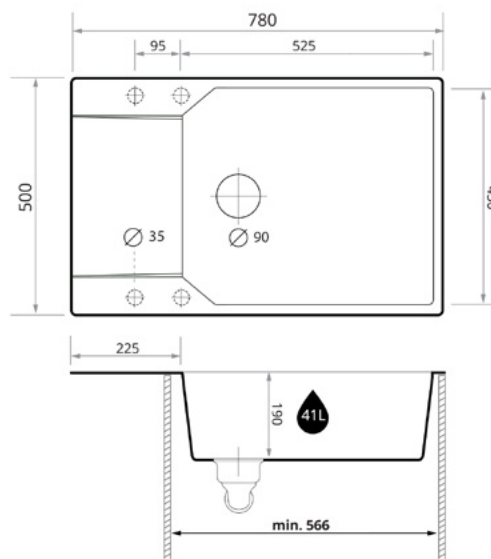

Dostępne akcesoria dodatkowe:



Osprzęt automatyczny



Opcje osprzętu



do szafki od 60cm



40 lat gwarancji



BrandeTec+



odporność na zarysowania



odporność na przebarwienia



odporność na wysoką temperaturę



odporność na zabrudzenia



odporność na uderzenia



odporność na szok termiczny



łatwe w czyszczeniu



nie traci koloru









elastyczność projektowania



komora XXL

◆● Lotus 590-60



	Black	B#MR6.KC.SM.001
	Black Metallic	B#MR6.KM.SM.001
	Graphite	B#MR6.KG.SM.001
	Grey	B#MR6.KS.SM.001
	Beige	B#MR6.KB.SM.001
	White	B#MR6.KW.SM.001

Cena katalogowa od:
1 199,99 PLN

W zestawie:



Osprzęt manualny

Dane techniczne

Rodzaj:	zlewozmywak nablatowy
Rozmiar szafki:	od 60 cm
Wymiary zewnętrzne:	590 x 500 mm
Wymiary komory:	540 x 460 x 190 mm
Odwracalny:	Nie
Liczba otworów:	3 podfrezowane otwory

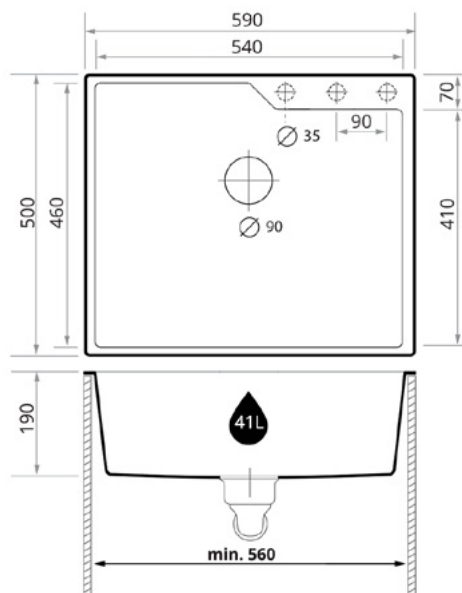

Dostępne akcesoria dodatkowe:



Osprzęt automatyczny



Opcje osprzętu



do szafki od 60cm



40 lat gwarancji



BrandTec+



odporność na zarysowania



odporność na przebarwienia



odporność na wysoką temperaturę



odporność na zabrudzenia



odporność na uderzenia



odporność na szok termiczny



łatwe w czyszczeniu



nie traci koloru



elastyczność projektowania



komora XXL

◆● Lotus Max 440-45

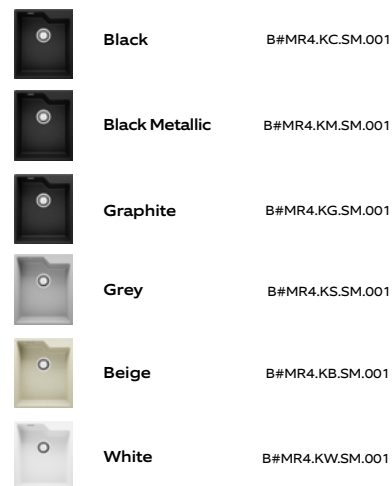

Cena katalogowa od:
1 199,99 PLN

W zestawie:



Osprzęt manualny

Dane techniczne

Rodzaj:	zlewozmywak nablatowy
Rozmiar szafki:	od 45 cm
Wymiary zewnętrzne:	440 x 530 mm
Wymiary komory:	400 x 490 x 190 mm
Odwracalny:	Nie
Liczba otworów:	2 podfrezowane otwory

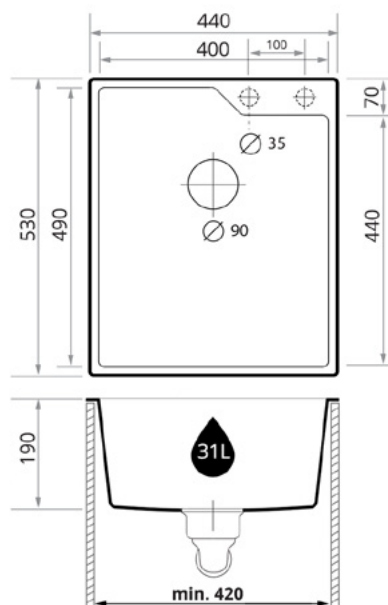

Dostępne akcesoria dodatkowe:



Osprzęt automatyczny



Opcje osprzętu



do szafki od 45cm



40 lat gwarancji



BrandTec+



odporność na zarysowania



odporność na przebarwienia



odporność na wysoką temperaturę



odporność na zabrudzenia



odporność na uderzenia



odporność na szok termiczny



łatwe w czyszczeniu



nie traci koloru



elastyczność projektowania



komora XXL



komora MAX



✦ Spire

Na wizualizacji model Spire 900-60



Spire 900-60

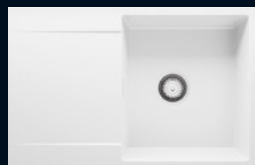

Spire 780-50

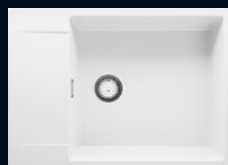

Spire 700-60

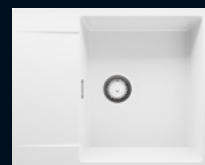

Spire 620-50

◆● Spire 900-60



	Black	B#MH9.KC.SM.001
	Black Metallic	B#MH9.KM.SM.001
	Graphite	B#MH9.KG.SM.001
	Grey	B#MH9.KS.SM.001
	Beige	B#MH9.KB.SM.001
	White	B#MH9.KW.SM.001

Cena katalogowa od:
1 499,99 PLN

W zestawie:



Osprzęt
manualny

Dane techniczne

Rodzaj:	zlewozmywak nablatowy
Rozmiar szafki:	od 60 cm
Wymiary zewnętrzne:	900 x 500 mm
Wymiary komory:	488 x 450 x 190 mm
Odwracalny:	Tak
Liczba otworów:	4 podfrezowane otwory

Dostępne akcesoria dodatkowe:



Osprzęt
automatyczny



Opcje osprzętu

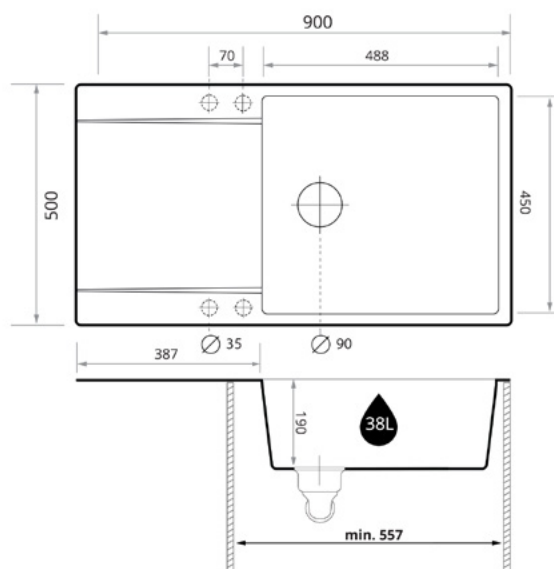

do szafki od 60cm



40 lat gwarancji



BrandeTec+



odporność na zarysowania



odporność na przebarwienia



odporność na wysoką temperaturę



odporność na zabrudzenia



odporność na uderzenia



odporność na szok termiczny



łatwe w czyszczeniu



nie traci koloru









elastyczność projektowania



komora XXL

◆● Spire 780-50



	Black	B#MH7.KC.SM.001
	Black Metallic	B#MH7.KM.SM.001
	Graphite	B#MH7.KG.SM.001
	Grey	B#MH7.KS.SM.001
	Beige	B#MH7.KB.SM.001
	White	B#MH7.KW.SM.001

Cena katalogowa od:
1 349,99 PLN

W zestawie:



Osprzęt
manualny

Dane techniczne

Rodzaj:	zlewozmywak nablatowy
Rozmiar szafki:	od 50 cm
Wymiary zewnętrzne:	780 x 500 mm
Wymiary komory:	400 x 450 x 190 mm
Odwracalny:	Tak
Liczba otworów:	4 podfrezowane otwory

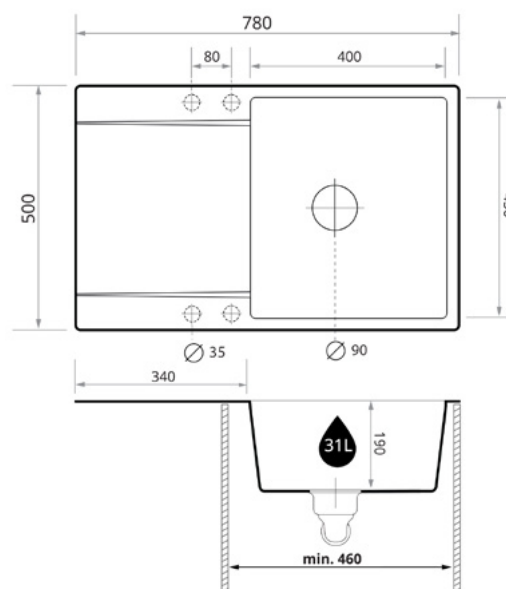

Dostępne akcesoria dodatkowe:



Osprzęt
automatyczny







Opcje osprzętu

-  do szafki od 50cm
-  40 lat gwarancji
-  BrandeTec+
-  odporność na zarysowania
-  odporność na przebarwienia
-  odporność na wysoką temperaturę
-  odporność na zabrudzenia
-  odporność na uderzenia
-  odporność na szok termiczny
-  łatwe w czyszczeniu
-  nie traci koloru
-  elastyczność projektowania

 komora XXL

◆● Spire 700-60



	Black	B#MHX.KC.SM.001
	Black Metallic	B#MHX.KM.SM.001
	Graphite	B#MHX.KG.SM.001
	Grey	B#MHX.KS.SM.001
	Beige	B#MHX.KB.SM.001
	White	B#MHX.KW.SM.001

Cena katalogowa od:
1 299,99 PLN

W zestawie:



Osprzęt manualny

Dane techniczne

Rodzaj:	zlewozmywak nablatowy
Rozmiar szafki:	od 60 cm
Wymiary zewnętrzne:	700 x 500 mm
Wymiary komory:	485 x 450 x 190 mm
Odwracalny:	Tak
Liczba otworów:	4 podfrezowane otwory

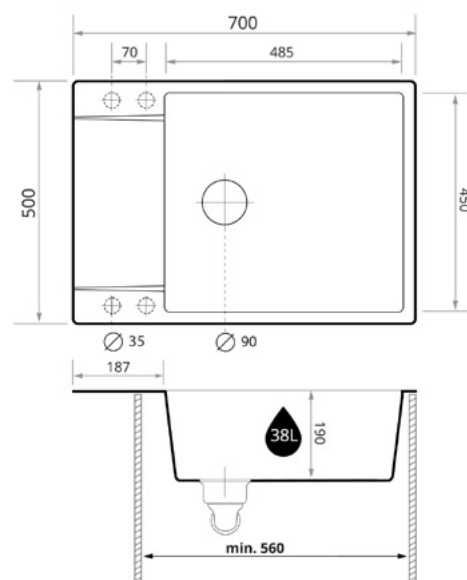

Dostępne akcesoria dodatkowe:



Osprzęt automatyczny



Opcje osprzętu



do szafki od 60cm



40 lat gwarancji



BrandTec+



odporność na zarysowania



odporność na przebarwienia



odporność na wysoką temperaturę



odporność na zabrudzenia



odporność na uderzenia



odporność na szok termiczny



łatwe w czyszczeniu



nie traci koloru



elastyczność projektowania





komora XXL



◆● Spire 620-50



	Black	B#MH6.KC.SM.001
	Black Metallic	B#MH6.KM.SM.001
	Graphite	B#MH6.KG.SM.001
	Grey	B#MH6.KS.SM.001
	Beige	B#MH6.KB.SM.001
	White	B#MH6.KW.SM.001

Cena katalogowa od:
1 249,99 PLN

W zestawie:



Osprzęt manualny

Dane techniczne

Rodzaj:	zlewozmywak nabladowy
Rozmiar szafki:	od 50 cm
Wymiary zewnętrzne:	620 x 500 mm
Wymiary komory:	390 x 450 x 190 mm
Odwracalny:	Tak
Liczba otworów:	4 podfrezowane otwory

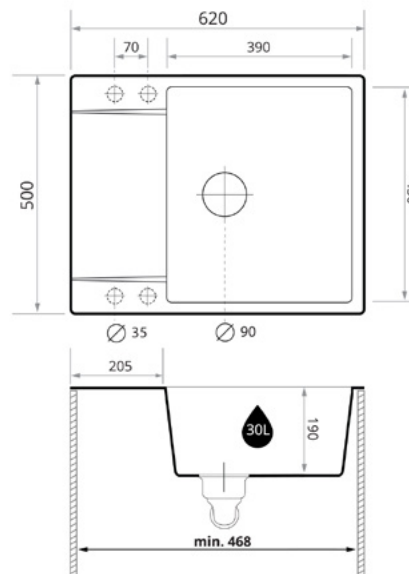

Dostępne akcesoria dodatkowe:



Osprzęt automatyczny



Opcje osprzętu



do szafki od 50cm



40 lat gwarancji



BrandeTec+



odporność na zarysowania



odporność na przebarwienia



odporność na wysoką temperaturę



odporność na zabrudzenia



odporność na uderzenia



odporność na szok termiczny



łatwe w czyszczeniu



nie traci koloru



elastyczność projektowania



komora XXL



Point

Na wizualizacji model Point 900-60

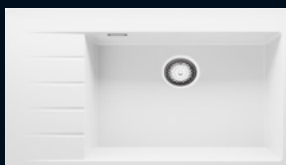

Point 900-60

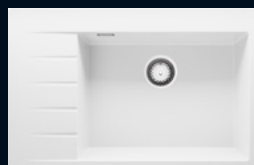

Point 780-60

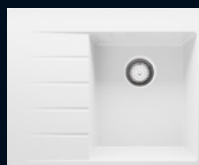

Point 620-40

◆● Point 900-60



	Black	B#MT9.KC.SM.001
	Black Metallic	B#MT9.KM.SM.001
	Graphite	B#MT9.KG.SM.001
	Grey	B#MT9.KS.SM.001
	Beige	B#MT9.KB.SM.001
	White	B#MT9.KW.SM.001

Cena katalogowa od:
1 449,99 PLN

W zestawie:



Osprzęt manualny

Dane techniczne

Rodzaj:	zlewozmywak nablátowy
Rozmiar szafki:	od 60 cm
Wymiary zewnętrzne:	900 x 500 mm
Wymiary komory:	540 x 400 x 190 mm
Odwracalny:	Tak
Liczba otworów:	5 podfrezowanych otworów

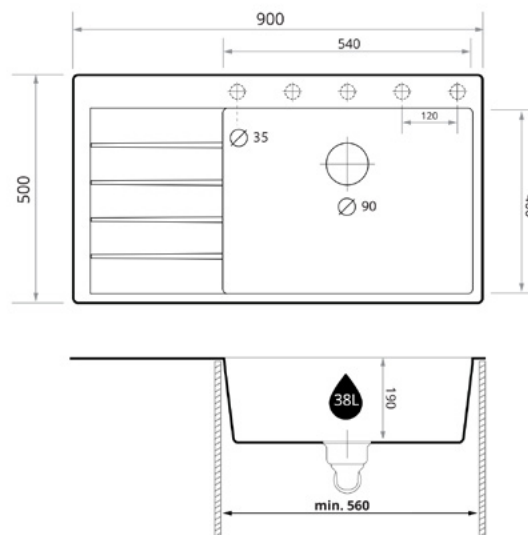

Dostępne akcesoria dodatkowe:



Osprzęt automatyczny



Opcje osprzętu



do szafki od 60cm



40 lat gwarancji



BrandTec+



odporność na zarysowania



odporność na przebarwienia



odporność na wysoką temperaturę



odporność na zabrudzenia



odporność na uderzenia



odporność na szok termiczny



łatwe w czyszczeniu



nie traci koloru





elastyczność projektowania



komora XXL

◆● Point 780-60



	Black	B#MT7.KC.SM.001
	Black Metallic	B#MT7.KM.SM.001
	Graphite	B#MT7.KG.SM.001
	Grey	B#MT7.KS.SM.001
	Beige	B#MT7.KB.SM.001
	White	B#MT7.KW.SM.001

Cena katalogowa od:
1 149,99 PLN

W zestawie:



Osprzęt manualny

Dane techniczne

Rodzaj:	zlewozmywak nablatowy
Rozmiar szafki:	od 60 cm
Wymiary zewnętrzne:	780 x 500 mm
Wymiary komory:	540 x 400 x 190 mm
Odwracalny:	Nie
Liczba otworów:	5 podfrezowanych otworów

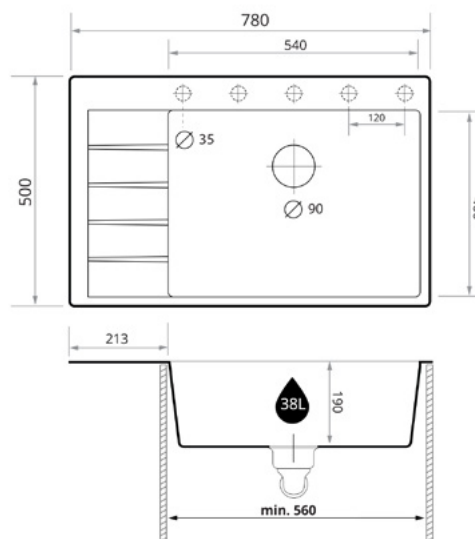

Dostępne akcesoria dodatkowe:



Osprzęt automatyczny







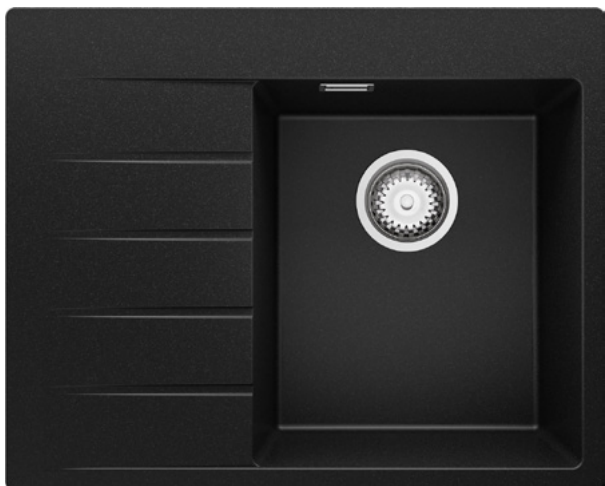

Opcje osprzętu

-  do szafki od 60cm
-  40 40 lat gwarancji
-  BrandeTec+
-  odporność na zarysowania
-  odporność na przebarwienia
-  odporność na wysoką temperaturę
-  odporność na zabrudzenia
-  odporność na uderzenia
-  + - odporność na szok termiczny
-  łatwe w czyszczeniu
-  nie traci koloru
-  elastyczność projektowania

 komora XXL

◆● Point 620-40



	Black	B#MT6.KC.SM.001
	Black Metallic	B#MT6.KM.SM.001
	Graphite	B#MT6.KG.SM.001
	Grey	B#MT6.KS.SM.001
	Beige	B#MT6.KB.SM.001
	White	B#MT6.KW.SM.001

Cena katalogowa od:
1 049,99 PLN

W zestawie:



Osprzęt manualny

Dane techniczne

Rodzaj:	zlewozmywak nablatowy
Rozmiar szafki:	od 40 cm
Wymiary zewnętrzne:	620 x 500 mm
Wymiary komory:	340 x 400 x 190 mm
Odwracalny:	Nie
Liczba otworów:	4 podfrezowane otwory

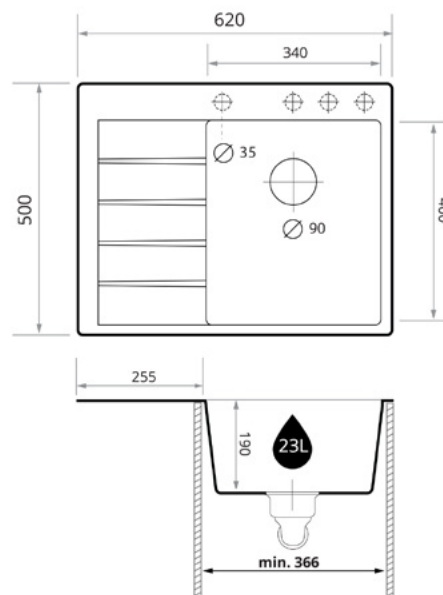

Dostępne akcesoria dodatkowe:



Osprzęt automatyczny



Opcje osprzętu



do szafki od 40cm



40 lat gwarancji



BrandTec+



odporność na zarysowania



odporność na przebarwienia



odporność na wysoką temperaturę



odporność na zabrudzenia



odporność na uderzenia



odporność na szok termiczny



łatwe w czyszczeniu



nie traci koloru



elastyczność projektowania



Ná vizualizácii model Link 900-60

Link



Link 900-60



Link Dual 900-60



Link Dual 900-80



Link 780-60



Link Dual 780-60



Link 780-50



Link 780-45



Link 620-50



Link 620-45

◆● Link 900-60



	Black	B#MK9.KC.SM.001
	Black Metallic	B#MK9.KM.SM.001
	Graphite	B#MK9.KG.SM.001
	Grey	B#MK9.KS.SM.001
	Beige	B#MK9.KB.SM.001
	White	B#MK9.KW.SM.001

Cena katalogowa od:
1 349,99 PLN

W zestawie:



Osprzęt manualny

Dane techniczne

Rodzaj:	zlewozmywak nablutowy
Rozmiar szafki:	od 60 cm
Wymiary zewnętrzne:	900 x 500 mm
Wymiary komory:	475 x 420 x 190 mm
Odwracalny:	Tak
Liczba otworów:	4 podfrezowane otwory

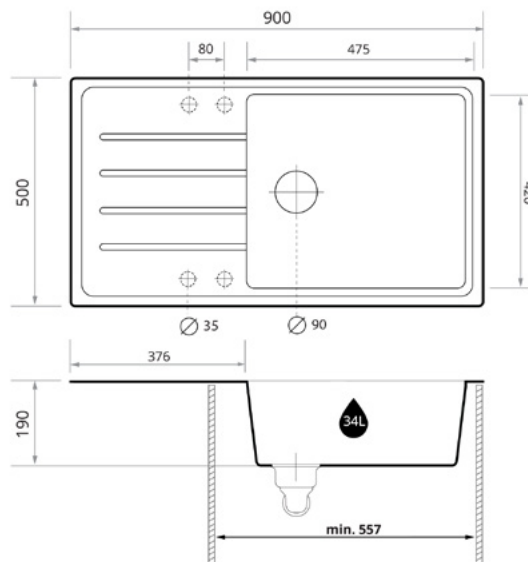

Dostępne akcesoria dodatkowe:



Osprzęt automatyczny



Opcje osprzętu



do szafki od 60cm



40 lat gwarancji



BrandTec+



odporność na zarysowania



odporność na przebarwienia



odporność na wysoką temperaturę



odporność na zabrudzenia



odporność na uderzenia



odporność na szok termiczny



łatwe w czyszczeniu



nie traci koloru



elastyczność projektowania



komora XXL

◆● Link Dual 900-60



	Black	B#MKD.KC.SM.001
	Black Metallic	B#MKD.KM.SM.001
	Graphite	B#MKD.KG.SM.001
	Grey	B#MKD.KS.SM.001
	Beige	B#MKD.KB.SM.001
	White	B#MKD.KW.SM.001

Cena katalogowa od:
1 349,99 PLN

W zestawie:



Osprzęt
manualny

Dane techniczne

Rodzaj:	zlewozmywak nablutowy
Rozmiar szafki:	od 60 cm
Wymiary zewnętrzne:	900 x 500 mm
Wymiary komory:	335 x 420 x 190 mm
Odwracalny:	Tak
Liczba otworów:	4 podfrezowane otwory

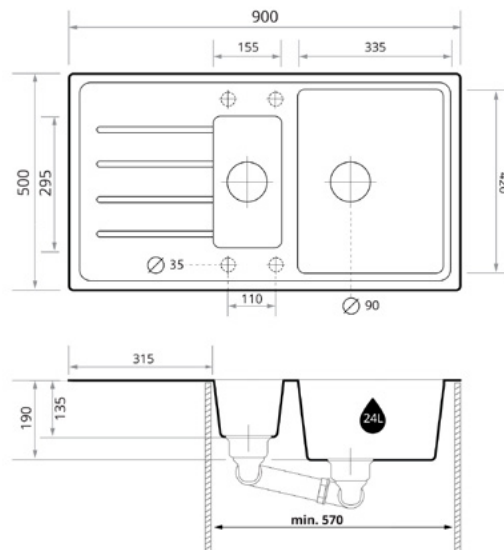

Dostępne akcesoria dodatkowe:



Osprzęt
automatyczny



Opcje osprzętu

-  do szafki od 60cm
-  40 lat gwarancji
-  BrandeTec+
-  odporność na zarysowania
-  odporność na przebarwienia
-  odporność na wysoką temperaturę
-  odporność na zabrudzenia
-  odporność na uderzenia
-  odporność na szok termiczny
-  łatwe w czyszczeniu
-  nie traci koloru
-  elastyczność projektowania

◆● Link Dual 900-80



	Black	B#MKC.KC.SM.001
	Black Metallic	B#MKC.KM.SM.001
	Graphite	B#MKC.KG.SM.001
	Grey	B#MKC.KS.SM.001
	Beige	B#MKC.KB.SM.001
	White	B#MKC.KW.SM.001

Cena katalogowa od:
1 649,99 PLN

W zestawie:



Osprzęt manualny

Dane techniczne

Rodzaj:	zlewozmywak nablutowy
Rozmiar szafki:	od 80 cm
Wymiary zewnętrzne:	900 x 500 mm
Wymiary komory:	326 x 390 x 190 mm
Odwracalny:	Nie
Liczba otworów:	5 podfrezowanych otworów

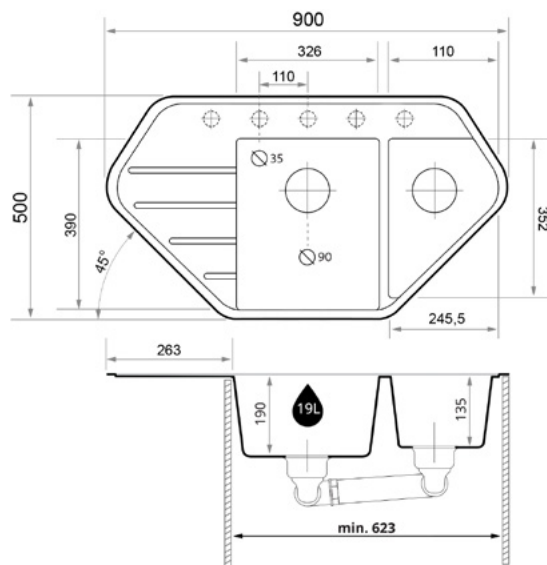

Dostępne akcesoria dodatkowe:



Osprzęt automatyczny



Opcje osprzętu



do szafki od 80cm



40 lat gwarancji



BrandTec+



odporność na zarysowania



odporność na przebarwienia



odporność na wysoką temperaturę



odporność na zabrudzenia



odporność na uderzenia



odporność na szok termiczny



łatwe w czyszczeniu



nie traci koloru



elastyczność projektowania

◆● Link 780-60



	Black	B#MKX.KC.SM.001
	Black Metallic	B#MKX.KM.SM.001
	Graphite	B#MKX.KG.SM.001
	Grey	B#MKX.KS.SM.001
	Beige	B#MKX.KB.SM.001
	White	B#MKX.KW.SM.001

Cena katalogowa od:
1 349,99 PLN

W zestawie:



Osprzęt manualny

Dane techniczne

Rodzaj:	zlewozmywak nablatowy
Rozmiar szafki:	od 60 cm
Wymiary zewnętrzne:	780 x 500 mm
Wymiary komory:	470 x 420 x 190 mm
Odwracalny:	Tak
Liczba otworów:	4 podfrezowane otwory

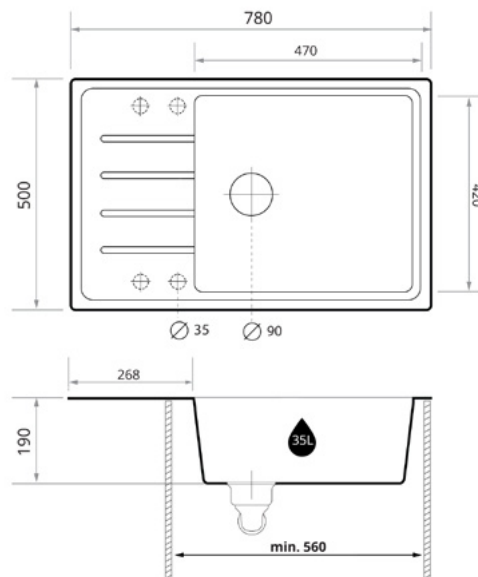

Dostępne akcesoria dodatkowe:



Osprzęt automatyczny





Opcje osprzętu

-  do szafki od 60cm
-  40 lat gwarancji
-  BrandeTec+
-  odporność na zarysowania
-  odporność na przebarwienia
-  odporność na wysoką temperaturę
-  odporność na zabrudzenia
-  odporność na uderzenia
-  odporność na szok termiczny
-  łatwe w czyszczeniu
-  nie traci koloru
-  elastyczność projektowania

 komora XXL

◆● Link Dual 780-60



	Black	B#MKE.KC.SM.001
	Black Metallic	B#MKE.KM.SM.001
	Graphite	B#MKE.KG.SM.001
	Grey	B#MKE.KS.SM.001
	Beige	B#MKE.KB.SM.001
	White	B#MKE.KW.SM.001

Cena katalogowa od:
1 349,99 PLN

W zestawie:



Osprzęt manualny

Dane techniczne

Rodzaj:	zlewozmywak nablatowy
Rozmiar szafki:	od 60 cm
Wymiary zewnętrzne:	780 x 500 mm
Wymiary komory:	335 x 420 x 190 mm
Odwracalny:	Tak
Liczba otworów:	4 podfrezowane otwory

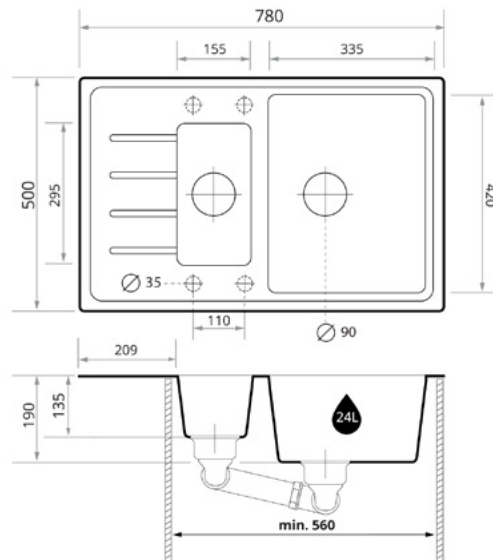

Dostępne akcesoria dodatkowe:



Osprzęt automatyczny



Opcje osprzętu



do szafki od 60cm



40 lat gwarancji



BrandeTec+



odporność na zarysowania



odporność na przebarwienia



odporność na wysoką temperaturę



odporność na zabrudzenia



odporność na uderzenia



odporność na szok termiczny



łatwe w czyszczeniu



nie traci koloru



elastyczność projektowania

◆● Link 780-50



	Black	B#MCE.KC.SM.001
	Black Metallic	B#MCE.KM.SM.001
	Graphite	B#MCE.KG.SM.001
	Grey	B#MCE.KS.SM.001
	Beige	B#MCE.KB.SM.001
	White	B#MCE.KW.SM.001

Cena katalogowa od:
1 299,99 PLN

W zestawie:



Osprzęt
manualny

Dane techniczne

Rodzaj:	zlewozmywak nablatowy
Rozmiar szafki:	od 50 cm
Wymiary zewnętrzne:	780 x 500 mm
Wymiary komory:	386 x 420 x 190 mm
Odwracalny:	Tak
Liczba otworów:	4 podfrezowane otwory

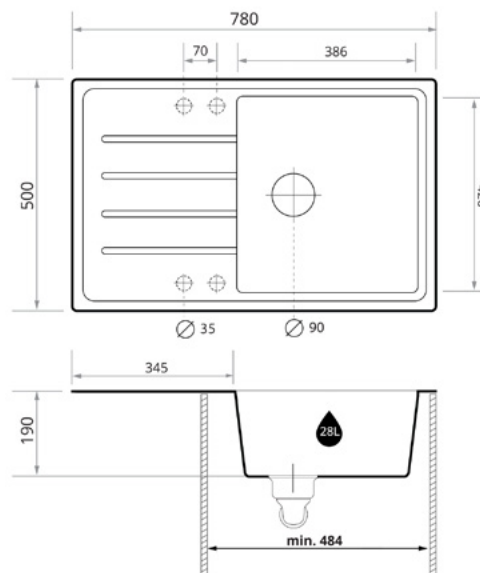

Dostępne akcesoria dodatkowe:



Osprzęt
automatyczny









Opcje osprzętu

-  do szafki od 50cm
-  40 lat gwarancji
-  BrandeTec+
-  odporność na zarysowania
-  odporność na przebarwienia
-  odporność na wysoką temperaturę
-  odporność na zabrudzenia
-  odporność na uderzenia
-  odporność na szok termiczny
-  łatwe w czyszczeniu
-  nie traci koloru
-  elastyczność projektowania

◆● Link 780-45



	Black	B#MK7.KC.SM.001
	Black Metallic	B#MK7.KM.SM.001
	Graphite	B#MK7.KG.SM.001
	Grey	B#MK7.KS.SM.001
	Beige	B#MK7.KB.SM.001
	White	B#MK7.KW.SM.001

Cena katalogowa od:
1 249,99 PLN

W zestawie:



Osprzęt manualny

Dane techniczne

Rodzaj:	zlewozmywak nablatowy
Rozmiar szafki:	od 45 cm
Wymiary zewnętrzne:	780 x 500 mm
Wymiary komory:	340 x 420 x 190 mm
Odwracalny:	Tak
Liczba otworów:	4 podfrezowane otwory

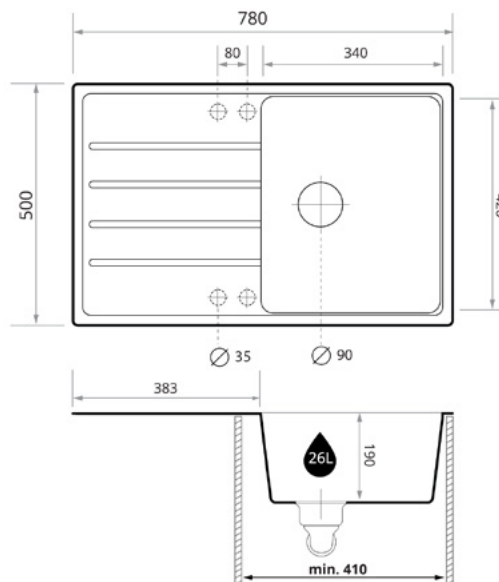

Dostępne akcesoria dodatkowe:



Osprzęt automatyczny



Opcje osprzętu



do szafki od 45cm



40 lat gwarancji



BrandeTec+



odporność na zarysowania



odporność na przebarwienia



odporność na wysoką temperaturę



odporność na zabrudzenia



odporność na uderzenia



odporność na szok termiczny



łatwe w czyszczeniu



nie traci koloru



elastyczność projektowania

◆● Link 620-50



	Black	B#MCS.KC.SM.001
	Black Metallic	B#MCS.KM.SM.001
	Graphite	B#MCS.KG.SM.001
	Grey	B#MCS.KS.SM.001
	Beige	B#MCS.KB.SM.001
	White	B#MCS.KW.SM.001

Cena katalogowa od:
1 249,99 PLN

W zestawie:



Osprzęt manualny

Dane techniczne

Rodzaj:	zlewozmywak nablatowy
Rozmiar szafki:	od 50 cm
Wymiary zewnętrzne:	620 x 500 mm
Wymiary komory:	386 x 420 x 190 mm
Odwracalny:	Tak
Liczba otworów:	4 podfrezowane otwory

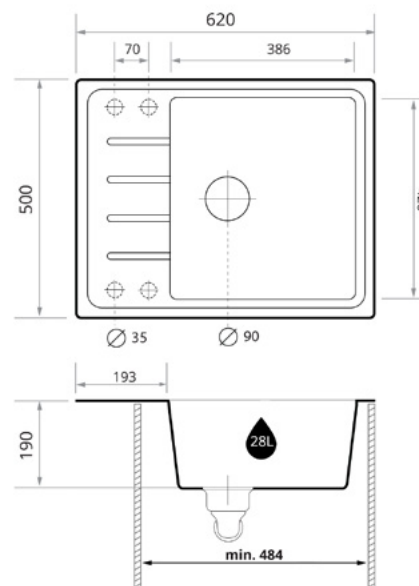

Dostępne akcesoria dodatkowe:



Osprzęt automatyczny









Opcje osprzętu

-  do szafki od 50cm
-  40 lat gwarancji
-  BrandeTec+
-  odporność na zarysowania
-  odporność na przebarwienia
-  odporność na wysoką temperaturę
-  odporność na zabrudzenia
-  odporność na uderzenia
-  odporność na szok termiczny
-  łatwe w czyszczeniu
-  nie traci koloru
-  elastyczność projektowania

◆● Link 620-45



	Black	B#MK6.KC.SM.001
	Black Metallic	B#MK6.KM.SM.001
	Graphite	B#MK6.KG.SM.001
	Grey	B#MK6.KS.SM.001
	Beige	B#MK6.KB.SM.001
	White	B#MK6.KW.SM.001

Cena katalogowa od:
1 199,99 PLN

W zestawie:



Osprzęt manualny

Dane techniczne

Rodzaj:	zlewozmywak nablatowy
Rozmiar szafki:	od 40 cm
Wymiary zewnętrzne:	62 x 500 mm
Wymiary komory:	340 x 420 x 190 mm
Odwracalny:	Tak
Liczba otworów:	4 podfrezowane otwory

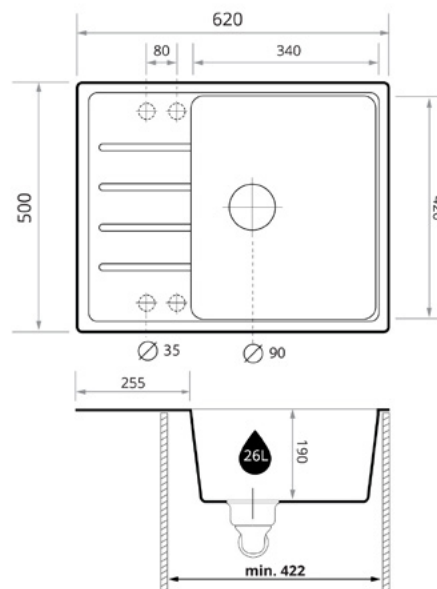

Dostępne akcesoria dodatkowe:



Osprzęt automatyczny



Opcje osprzętu



do szafki od 40cm



40 lat gwarancji



BrandeTec+



odporność na zarysowania



odporność na przebarwienia



odporność na wysoką temperaturę



odporność na zabrudzenia



odporność na uderzenia



odporność na szok termiczny



łatwe w czyszczeniu



nie traci koloru



elastyczność projektowania



✦ Mach

Na wizualizacji model Mach 620-40

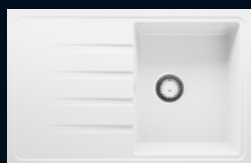

Mach 780-45

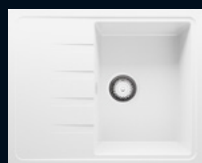

Mach 620-40

✦● Mach 780-45



	Black	B#MC7.KC.SM.001
	Black Metallic	B#MC7.KM.SM.001
	Graphite	B#MC7.KG.SM.001
	Grey	B#MC7.KS.SM.001
	Beige	B#MC7.KB.SM.001
	White	B#MC7.KW.SM.001

Cena katalogowa od:
1 049,99 PLN

W zestawie:



Osprzęt manualny

Dane techniczne

Rodzaj:	zlewozmywak nablatowy
Rozmiar szafki:	od 45 cm
Wymiary zewnętrzne:	780 x 500 mm
Wymiary komory:	340 x 420 x 190 mm
Odwracalny:	Tak
Liczba otworów:	4 podfrezowane otwory

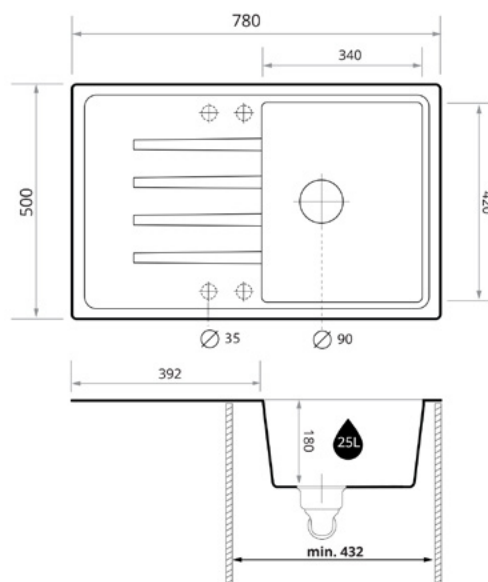

Dostępne akcesoria dodatkowe:



Osprzęt automatyczny



Opcje osprzętu



do szafki od 45cm



40 lat gwarancji



BrandeTec+



odporność na zarysowania



odporność na przebarwienia



odporność na wysoką temperaturę



odporność na zabrudzenia



odporność na uderzenia



odporność na szok termiczny



łatwe w czyszczeniu



nie traci koloru







elastyczność projektowania

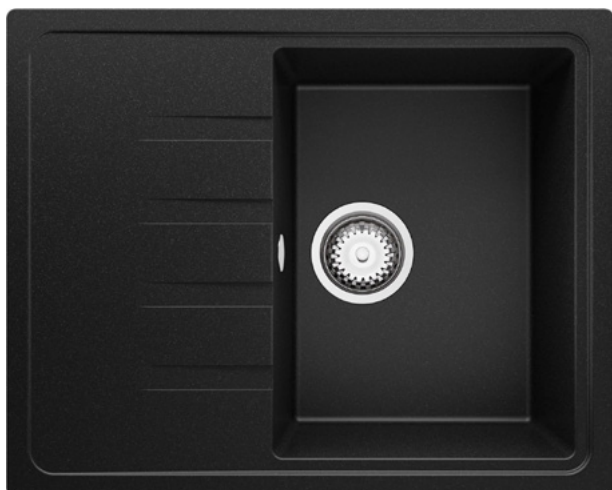

◆● Mach 620-40



	Black	B#MC4.KC.SM.001
	Black Metallic	B#MC4.KM.SM.001
	Graphite	B#MC4.KG.SM.001
	Grey	B#MC4.KS.SM.001
	Beige	B#MC4.KB.SM.001
	White	B#MC4.KW.SM.001

Cena katalogowa od:
999,99 PLN

W zestawie:



Osprzęt manualny

Dane techniczne

Rodzaj:	zlewozmywak nabladowy
Rozmiar szafki:	od 40 cm
Wymiary zewnętrzne:	620 x 500 mm
Wymiary komory:	310 x 420 x 190 mm
Odwracalny:	Tak
Liczba otworów:	4 podfrezowane otwory

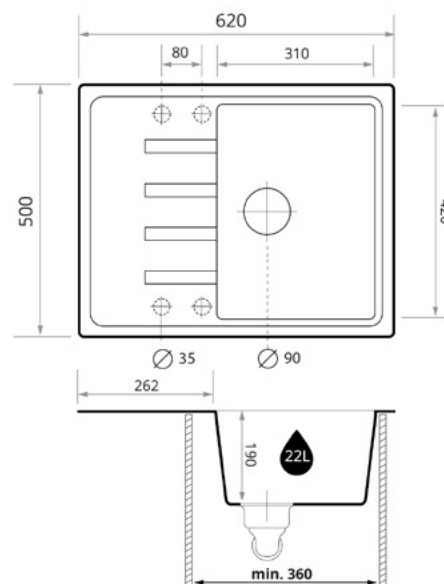

Dostępne akcesoria dodatkowe:



Osprzęt automatyczny



Opcje osprzętu

-  do szafki od 40cm
-  40 lat gwarancji
-  BrandeTec+
-  odporność na zarysowania
-  odporność na przebarwienia
-  odporność na wysoką temperaturę
-  odporność na zabrudzenia
-  odporność na uderzenia
-  odporność na szok termiczny
-  łatwe w czyszczeniu
-  nie traci koloru
-  elastyczność projektowania





◆ ● Zlewozmywaki podblatowe



High

◆● High 560-60



	Black	B#MZ6.KC.SM.100
	Black Metallic	B#MZ6.KM.SM.100
	Graphite	B#MZ6.KG.SM.100
	Grey	B#MZ6.KS.SM.100
	Beige	B#MZ6.KB.SM.100
	White	B#MZ6.KW.SM.100

Cena katalogowa od:
2 649,99 PLN

W zestawie:



Osprzęt manualny



Zwijany ociekacz chrom



Maskownica "Line"

Dane techniczne

Rodzaj:	zlewozmywak podblatowy
Rozmiar szafki:	od 60 cm
Wymiary zewnętrzne:	560 x 470 mm
Wymiary komory:	520 x 430 x 200 mm
Odwracalny:	Nie

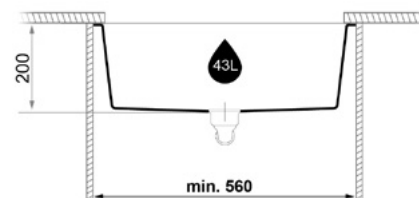
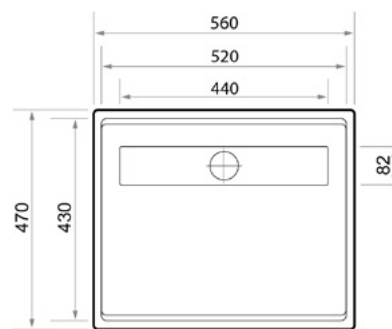

Dostępne akcesoria dodatkowe:



Osprzęt automatyczny



Czarna maskownica "Line"



Zwijany ociekacz czarny mat



Wkładka ociekowa



Deska kuchenna bukowa lub dębowa



Deska kuchenna HPL



do szafki od 60cm



40 lat gwarancji



BrandeTec+



odporność na zarysowania



odporność na przebarwienia



odporność na wysoką temperaturę



odporność na zabrudzenia



odporność na uderzenia



odporność na szok termiczny



łatwe w czyszczeniu



nie traci koloru



komora XXL



system Level



✦ Hype

◆● Hype 560-60

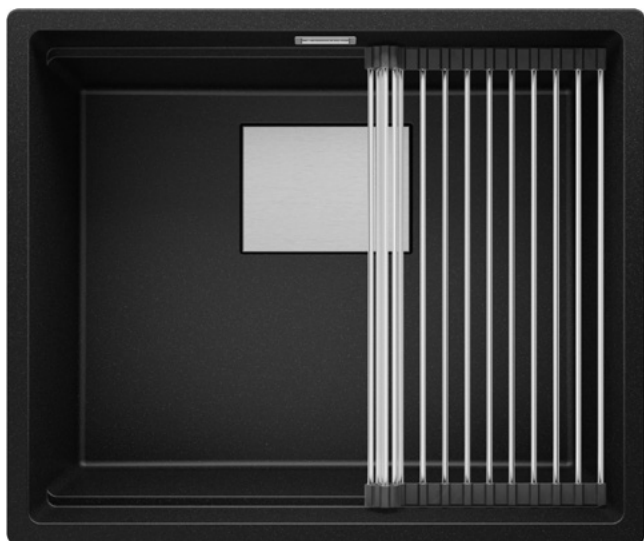

	Black	B#MG6.KC.SM.100
	Black Metallic	B#MG6.KM.SM.100
	Graphite	B#MG6.KG.SM.100
	Grey	B#MG6.KS.SM.100
	Beige	B#MG6.KB.SM.100
	White	B#MG6.KW.SM.100

Cena katalogowa od:
2 149,99 PLN

W zestawie:



Osprzęt manualny



Zwijany ociekacz chrom



Maskownica "R"

Dane techniczne

Rodzaj:	zlewozmywak podblatowy
Rozmiar szafki:	od 60 cm
Wymiary zewnętrzne:	560 x 470 mm
Wymiary komory:	520 x 430 x 200 mm
Odwracalny:	Nie

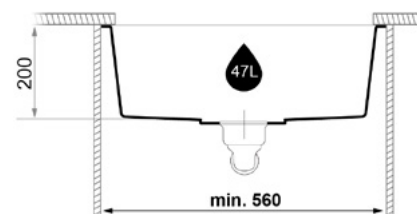
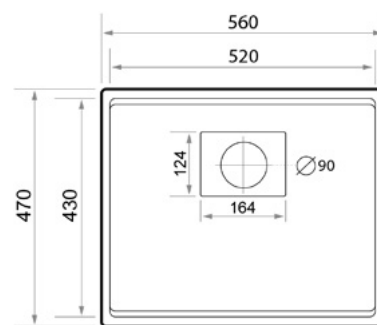

Dostępne akcesoria dodatkowe:



Osprzęt automatyczny



Czarna maskownica "R"



Zwijany ociekacz czarny mat



Wkładka ociekowa



Deska kuchenna bukowa lub dębowa



Deska kuchenna HPL



do szafki od 60cm



40 lat gwarancji



BrandeTec+



odporność na zarysowania



odporność na przebarwienia



odporność na wysoką temperaturę



odporność na zabrudzenia



odporność na uderzenia



odporność na szok termiczny



łatwe w czyszczeniu



nie traci koloru



komora XXL



system Level



Swift

Na wizualizacji model Swift 580-60



Swift 860-90



Swift 760-80



Swift 580-60

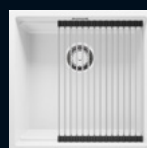

Swift Grande
560-60



Swift 460-50



Swift 410-45



Swift 360-40



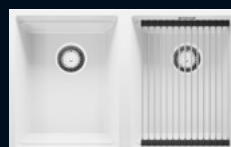

Swift Low Cut
760-80



Swift Dual
760-80

◆● Swift 860-90



	Black	B#MPN.KC.SM.100
	Black Metallic	B#MPN.KM.SM.100
	Graphite	B#MPN.KG.SM.100
	Grey	B#MPN.KS.SM.100
	Beige	B#MPN.KB.SM.100
	White	B#MPN.KW.SM.100

Cena katalogowa od:
1 999,99 PLN

W zestawie:



Osprzęt manualny



Zwijany ociekacz chrom

Dane techniczne

Rodzaj:	zlewozmywak podblatowy
Rozmiar szafki:	od 90 cm
Wymiary zewnętrzne:	860 x 470 mm
Wymiary komory:	820 x 430 x 200 mm
Odwracalny:	Nie

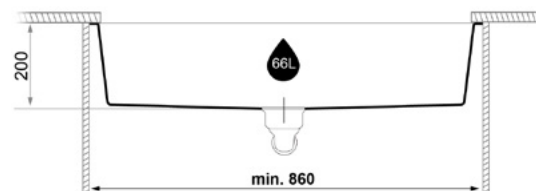
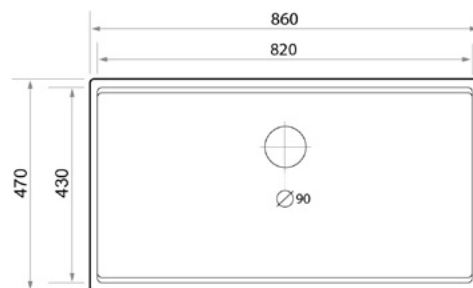

Dostępne akcesoria dodatkowe:



Osprzęt automatyczny



Opcje osprzętu



Zwijany ociekacz czarny mat



Wkładka ociekowa



Deska kuchenna bukowa lub dębowa



Deska kuchenna HPL



do szafki od 90cm



40 lat gwarancji



BrandeTec+



odporność na zarysowania



odporność na przebarwienia



odporność na wysoką temperaturę



odporność na zabrudzenia



odporność na uderzenia



odporność na szok termiczny



łatwe w czyszczeniu



nie traci koloru



komora XXL



system Level

◆● Swift 760-80

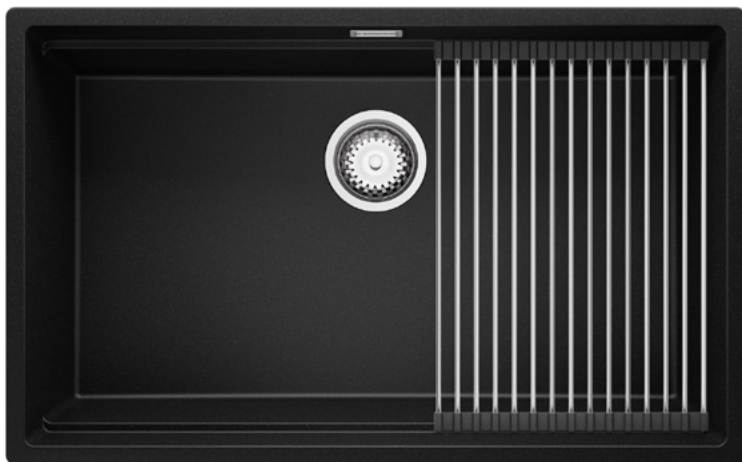

	Black	B#MP8.KC.SM.100
	Black Metallic	B#MP8.KM.SM.100
	Graphite	B#MP8.KG.SM.100
	Grey	B#MP8.KS.SM.100
	Beige	B#MP8.KB.SM.100
	White	B#MP8.KW.SM.100

Cena katalogowa od:
1 799,99 PLN

W zestawie:



Osprzęt manualny



Zwijany ociekacz chrom

Dane techniczne

Rodzaj:	zlewozmywak podblatowy
Rozmiar szafki:	od 80 cm
Wymiary zewnętrzne:	760 x 470 mm
Wymiary komory:	720 x 430 x 200 mm
Odwracalny:	Nie

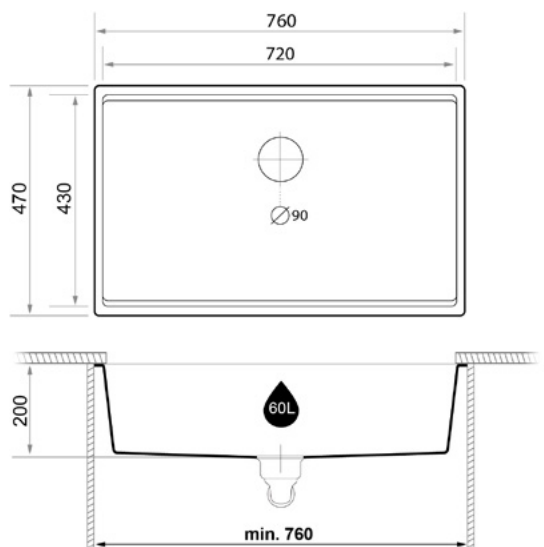

Dostępne akcesoria dodatkowe:



Osprzęt automatyczny



Opcje osprzętu



Zwijany ociekacz czarny mat



Wkładka ociekowa



Deska kuchenna bukowa lub dębowa



Deska kuchenna HPL



do szafki od 80cm



40 lat gwarancji



BrandeTec+



odporność na zarysowania



odporność na przebarwienia



odporność na wysoką temperaturę



odporność na zabrudzenia



odporność na uderzenia



odporność na szok termiczny



łatwe w czyszczeniu



nie traci koloru



komora XXL



system Level

◆● Swift 560-60

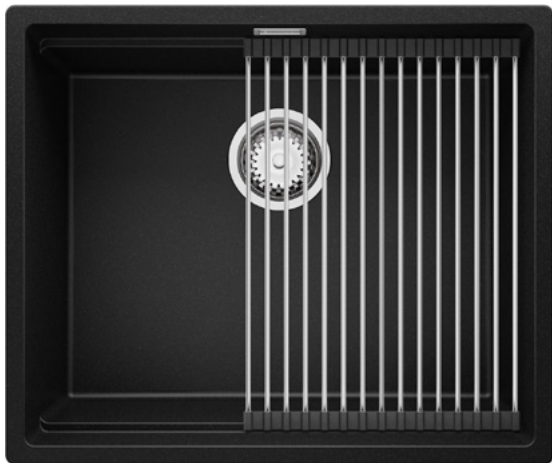

	Black	B#MP6.KC.SM.100
	Black Metallic	B#MP6.KM.SM.100
	Graphite	B#MP6.KG.SM.100
	Grey	B#MP6.KS.SM.100
	Beige	B#MP6.KB.SM.100
	White	B#MP6.KW.SM.100

W zestawie:



Osprzęt manualny



Zwijany ociekacz chrom

Cena katalogowa od:
1 499,99 PLN

Dane techniczne

Rodzaj:	zlewozmywak podblatowy
Rozmiar szafki:	od 60 cm
Wymiary zewnętrzne:	560 x 470 mm
Wymiary komory:	520 x 430 x 200 mm
Odwracalny:	Nie

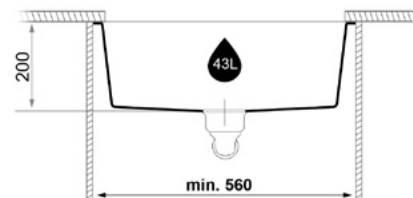
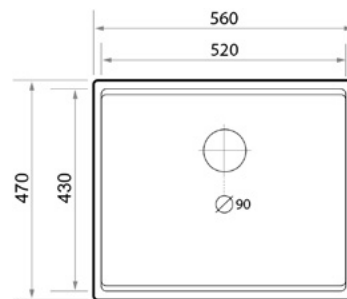

Dostępne akcesoria dodatkowe:



Osprzęt automatyczny



Opcje osprzętu



Zwijany ociekacz czarny mat



Wkładka ociekowa



Deska kuchenna bukowa lub dębowa



Deska kuchenna HPL



do szafki od 60cm



40 lat gwarancji



BrandeTec+



odporność na zarysowania



odporność na przebarwienia



odporność na wysoką temperaturę



odporność na zabrudzenia



odporność na uderzenia



odporność na szok termiczny



łatwe w czyszczeniu



nie traci koloru



komora XXL



system Level



◆● Swift 410-45



Black	B#MP5.KC.SM.100
Black Metallic	B#MP5.KM.SM.100
Graphite	B#MP5.KG.SM.100
Grey	B#MP5.KS.SM.100
Beige	B#MP5.KB.SM.100
White	B#MP5.KW.SM.100

W zestawie:



Osprzęt manualny



Zwijany ociekacz chrom

Cena katalogowa od:
1 249,99 PLN

Dane techniczne

Rodzaj:	zlewozmywak podblatowy
Rozmiar szafki:	od 45 cm
Wymiary zewnętrzne:	410 x 470 mm
Wymiary komory:	370 x 430 x 200 mm
Odwracalny:	Nie

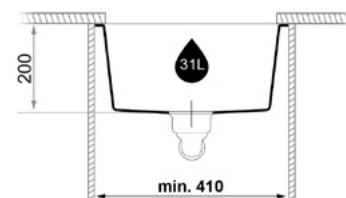
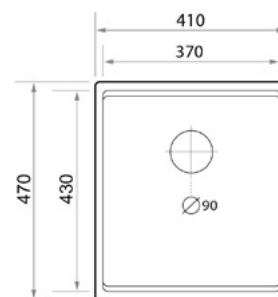

Dostępne akcesoria dodatkowe:



Osprzęt automatyczny



Opcje osprzętu



Zwijany ociekacz czarny mat



Wkładka ociekowa



Deska kuchenna bukowa lub dębowa



Deska kuchenna HPL



do szafki od 45cm



40 lat gwarancji



BrandeTec+



odporność na zarysowania



odporność na przebarwienia



odporność na wysoką temperaturę



odporność na zabrudzenia



odporność na uderzenia



odporność na szok termiczny



łatwe w czyszczeniu



nie traci koloru



system Level



✦ Solar

Na wizualizacji model Solar 580-60 oraz 260-30



Solar 760-80



Solar 660-70

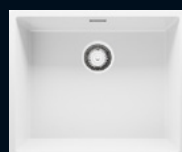

Solar 560-60

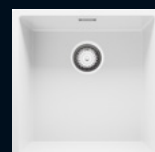

Solar 460-50

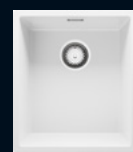

Solar 410-45

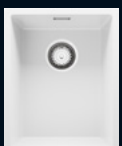







Solar 360-40



Solar 260-30

◆● Solar 760-80



	Black	B#ML8.KC.SM.100
	Black Metallic	B#ML8.KM.SM.100
	Graphite	B#ML8.KG.SM.100
	Grey	B#ML8.KS.SM.100
	Beige	B#ML8.KB.SM.100
	White	B#ML8.KW.SM.100

Cena katalogowa od:
1 599,99 PLN

W zestawie:



Osprzęt manualny

Dane techniczne

Rodzaj:	zlewozmywak podblatowy
Rozmiar szafki:	od 80 cm
Wymiary zewnętrzne:	760 x 470 mm
Wymiary komory:	720 x 430 x 200 mm
Odwracalny:	Nie

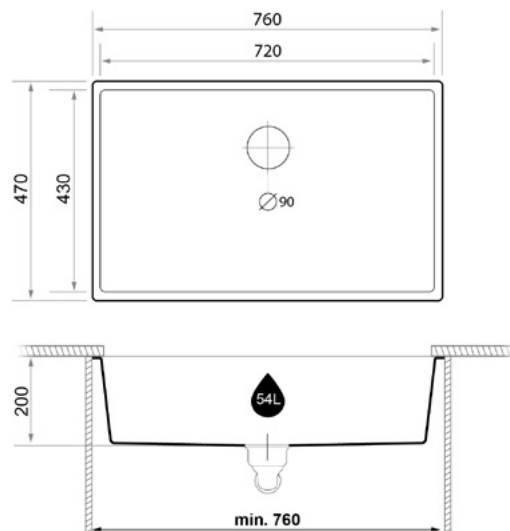

Dostępne akcesoria dodatkowe:



Osprzęt automatyczny



Opcje osprzętu



Deska kuchenna bukowa lub dębowa



Deska kuchenna HPL



do szafki od 80cm



40 lat gwarancji



BrandTec+



odporność na zarysowania



odporność na przebarwienia



odporność na wysoką temperaturę



odporność na zabrudzenia



odporność na uderzenia



odporność na szok termiczny







łatwe w czyszczeniu



nie traci koloru

◆● Solar 660-70



	Black	B#ML7.KC.SM.100
	Black Metallic	B#ML7.KM.SM.100
	Graphite	B#ML7.KG.SM.100
	Grey	B#ML7.KS.SM.100
	Beige	B#ML7.KB.SM.100
	White	B#ML7.KW.SM.100

Cena katalogowa od:
1 549,99 PLN

W zestawie:



Osprzęt
manualny

Dane techniczne

Rodzaj:	zlewozmywak podblatowy
Rozmiar szafki:	od 70 cm
Wymiary zewnętrzne:	660 x 470 mm
Wymiary komory:	620 x 430 x 200 mm
Odwracalny:	Nie

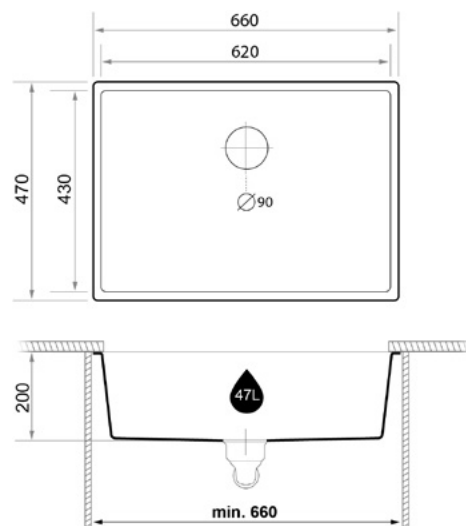

Dostępne akcesoria dodatkowe:



Osprzęt
automatyczny



Opcje osprzętu



Deska kuchenna
bukowa lub dębowa



Deska kuchenna
HPL



do szafki od 70cm



40 lat gwarancji



BrandeTec+



odporność na zarysowania



odporność na
przebarwienia



odporność na wysoką
temperaturę



odporność na zabrudzenia



odporność na uderzenia



odporność na
szok termiczny



łatwe w czyszczeniu



nie traci koloru

◆● Solar 560-60



	Black	B#ML6.KC.SM.100
	Black Metallic	B#ML6.KM.SM.100
	Graphite	B#ML6.KG.SM.100
	Grey	B#ML6.KS.SM.100
	Beige	B#ML6.KB.SM.100
	White	B#ML6.KW.SM.100

Cena katalogowa od:
1 299,99 PLN

W zestawie:



Osprzęt manualny

Dane techniczne

Rodzaj:	zlewozmywak podblatowy
Rozmiar szafki:	od 60 cm
Wymiary zewnętrzne:	560 x 470 mm
Wymiary komory:	520 x 430 x 200 mm
Odwracalny:	Nie

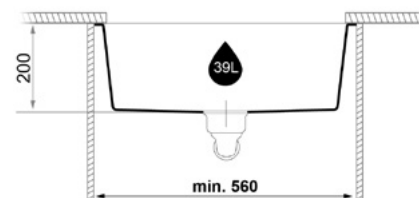
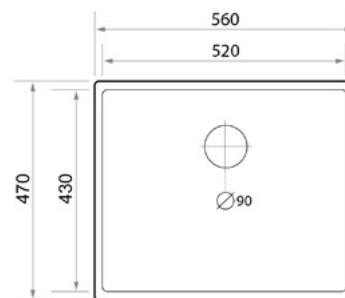

Dostępne akcesoria dodatkowe:



Osprzęt automatyczny



Opcje osprzętu



Deska kuchenna bukowa lub dębowa



Deska kuchenna HPL



do szafki od 60cm



40 lat gwarancji



BrandeTec+



odporność na zarysowania



odporność na przebarwienia



odporność na wysoką temperaturę



odporność na zabrudzenia



odporność na uderzenia



odporność na szok termiczny









łatwe w czyszczeniu



nie traci koloru

◆● Solar 460-50



	Black	B#ML5.KC.SM.100
	Black Metallic	B#ML5.KM.SM.100
	Graphite	B#ML5.KG.SM.100
	Grey	B#ML5.KS.SM.100
	Beige	B#ML5.KB.SM.100
	White	B#ML5.KW.SM.100

Cena katalogowa od:
1 249,99 PLN

W zestawie:



Osprzęt manualny

Dane techniczne

Rodzaj:	zlewozmywak podblatowy
Rozmiar szafki:	od 50 cm
Wymiary zewnętrzne:	460 x 470 mm
Wymiary komory:	420 x 430 x 200 mm
Odwracalny:	Nie

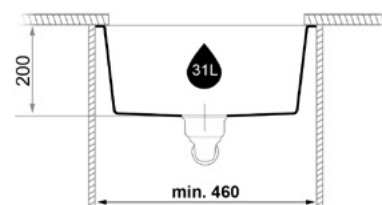
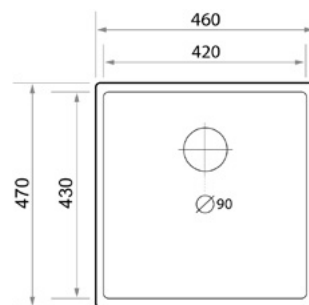

Dostępne akcesoria dodatkowe:



Osprzęt automatyczny



Opcje osprzętu



Deska kuchenna bukowa lub dębowa



Deska kuchenna HPL



do szafki od 50cm



40 lat gwarancji



BrandeTec+



odporność na zarysowania



odporność na przebarwienia



odporność na wysoką temperaturę



odporność na zabrudzenia



odporność na uderzenia



odporność na szok termiczny



łatwe w czyszczeniu



nie traci koloru

◆● Solar 410-45



	Black	B#ML4.KC.SM.100
	Black Metallic	B#ML4.KM.SM.100
	Graphite	B#ML4.KG.SM.100
	Grey	B#ML4.KS.SM.100
	Beige	B#ML4.KB.SM.100
	White	B#ML4.KW.SM.100

Cena katalogowa od:
1 149,99 PLN

W zestawie:



Dane techniczne

Rodzaj:	zlewozmywak podblatowy
Rozmiar szafki:	od 45 cm
Wymiary zewnętrzne:	410 x 470 mm
Wymiary komory:	370 x 430 x 200 mm
Odwracalny:	Nie

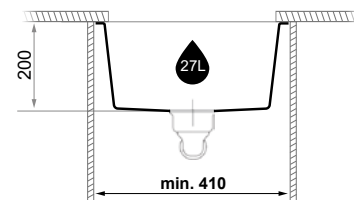
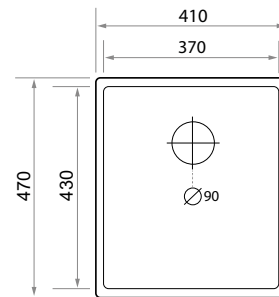

Dostępne akcesoria dodatkowe:



do szafki od 45cm



40 lat gwarancji



BrandeTec+



odporność na zarysowania



odporność na przebarwienia



odporność na wysoką temperaturę



odporność na zabrudzenia



odporność na uderzenia



odporność na szok termiczny



łatwe w czyszczeniu



nie traci koloru

◆● Solar 360-40



	Black	B#MLF.KC.SM.100
	Black Metallic	B#MLF.KM.SM.100
	Graphite	B#MLF.KG.SM.100
	Grey	B#MLF.KS.SM.100
	Beige	B#MLF.KB.SM.100
	White	B#MLF.KW.SM.100

Cena katalogowa od:
1 099,99 PLN

W zestawie:



Osprzęt
manualny

Dane techniczne

Rodzaj:	zlewozmywak podblatowy
Rozmiar szafki:	od 40 cm
Wymiary zewnętrzne:	360 x 470 mm
Wymiary komory:	320 x 430 x 200 mm
Odwracalny:	Nie

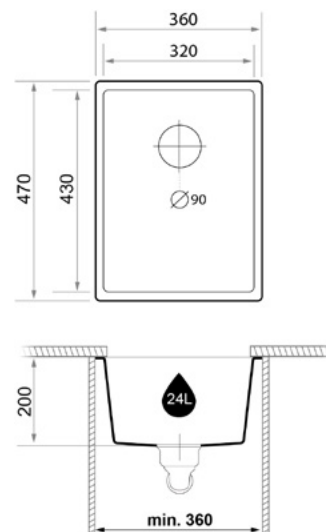

Dostępne akcesoria dodatkowe:



Osprzęt
automatyczny



Opcje osprzętu



Deska kuchenna
bukowa lub dębowa



Deska kuchenna
HPL



do szafki od 40cm



40 lat gwarancji



BrandeTec+



odporność na zarysowania



odporność na
przebarwienia



odporność na wysoką
temperaturę



odporność na zabrudzenia



odporność na uderzenia



odporność na
szok termiczny



łatwe w czyszczeniu



nie traci koloru

◆● Solar 260-30



Black B#ML3.KC.SM.100

Black Metallic B#ML3.KM.SM.100

Graphite B#ML3.KG.SM.100

Grey B#ML3.KS.SM.100

Beige B#ML3.KB.SM.100

White B#ML3.KW.SM.100

Cena katalogowa od:
1 049,99 PLN

W zestawie:



Osprzęt
manualny

Dane techniczne

Rodzaj:	zlewozmywak podblatowy
Rozmiar szafki:	od 30 cm
Wymiary zewnętrzne:	260 x 470 mm
Wymiary komory:	220 x 430 x 200 mm
Odwracalny:	Nie

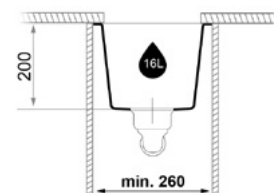
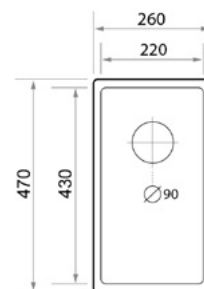

Dostępne akcesoria dodatkowe:



Osprzęt
automatyczny



Opcje osprzętu



Deska kuchenna
bukowa lub dębowa



Deska kuchenna
HPL



do szafki od 30cm



40 lat gwarancji



BrandeTec+



odporność na zarysowania



odporność na
przebarwienia



odporność na wysoką
temperaturę



odporność na
zabrudzenia



odporność na uderzenia



odporność na
szok termiczny



łatwe w czyszczeniu



nie traci koloru



Na stronie www.brande.pl przygotowaliśmy do pobrania instrukcje, gwarancje oraz oświadczenia i deklaracje, które poświadczają najwyższą jakość produktów BRANDE. Dla architektów i pasjonatów projektowania udostępniamy bazy plików 3D.



www.brande.pl

Adnotacja prawna

Ceny prezentowane w niniejszym materiale są ważne od 01.04.2023 do daty publikacji kolejnego cennika dostępnego na stronie www.brande.pl.

Wszystkie podane ceny są sugerowanymi cenami detalicznymi z uwzględnieniem podatku VAT w stawce podstawowej 23%. Z uwagi na wprowadzanie udoskonaleń technologicznych marka Brande zastrzega sobie możliwość wprowadzenia zmian w asortymencie i/lub danych technicznych produktów. Niniejszy materiał nie stanowi oferty w rozumieniu Kodeksu Cywilnego. Marka Brande nie ponosi odpowiedzialności za ewentualne błędy edytorskie. Kolory produktów w druku mogą nieznacznie odbiegać od oryginału.

Brande 2023 © Wszystkie prawa zastrzeżone.

Właścicielem marki Brande jest Primagran Sp. z o. o. z siedzibą w Żuławkach, Żuławki 15C, 82-103 Stegna. Działalność gospodarcza jest wpisana do KRS przez Sąd Rejonowy Gdańsk-Północ w Gdańsku KRS 0000367567, NIP 9571039974, kapitał zakładowy 500 000 PLN



✦● Quality by design

kontakt@brande.pl
+48 606 258 776
www.brande.pl



RF000049

